

# „easy xx” controllers for Brushless motors

„easy xx“ is a new line of controllers which are extremely simple to use - the easiest way it can be. Controllers are ready for an immediate start without any prior settings - everything is done automatically. Despite the simple use, the controllers maintain the high standard of quality such as the other MGM compro controllers. They are designed for brushless senseless motors (BLCD). If the user wishes to use any of the preset parameters, it may be done through a simple procedure using throttle stick. The set parameters are then permanently saved to a controller's memory.

Thanks to the hi-tech TMM<sup>®</sup> technology of MGM compro<sup>®</sup>, controllers have many outstanding features which significantly minimize the possible damage or destroy of motor, as well as batteries and the controller itself. The controllers ensure the maximal efficiency of the drive with different motors. They also feature extremely fine regulation and very soft starts. The BEC is very powerful (except easy 7, minimum dimensions and weight is preferred here). **All controllers are designed for Lipol cells and perfectly watch their minimal voltage;** they are certainly designed to work with NiCd/NiMH batteries as well.

## Basic features of „easy xx“ :

- **immediately ready to fly, no settings or programming necessary - the easiest way it can be**
- easy programming (setting) several important parameter using your transmitter
- **outstanding protection and management of Lipol / Li-Ion (very important) and NiCd / NiMH batteries**
- **perfect work with all types of motors – outrunners and standard (inner rotor) motors also**
- perfect masking of signal interference and losses
- **extremely smooth throttle step** (1023 steps)
- very soft starts
- motor and controller overload protection
- small dimensions and weight
- **very powerful BEC**

## Fast and easy to air:

To ensure correct type of the controller for each set (batteries, motor and propeller) it is best to measure (recommended is a clamp A-meter) current drawn from batteries when connected to the motor with propeller. It is necessary to carry out the measurement with the „hardest” batteries intended for use in this set. This will prevent problems that might occur when the controller is overloaded (and/or batteries and motor as well). Remember to ensure proper cooling of the controller, especially when working near limit parameters.

It is not possible to control more than one motor with one controller.

## 1) How to connect the controller:

- Opposite piece of the connector, which is on your accumulators, should be soldered to the leading-in conductors to the accumulator. Use only quality golden plated kinds. Recommend are MP JET 1.8mm, 2.5 mm or 3.5 mm according to the type of controller and current. We recommend to put socket on the “-” wire (black wire) of the controller and the plug on the “+” wire (red wire).
- The leads to the motor (yellow wires marked “A”, “B”, “C”) should be soldered directly to the motor or it is also possible to use the connectors mentioned above. If you decide to use connectors, this time solder sockets to the controller leads.
- After the connectors are soldered it is necessary to insulate them, for example with heat shrinking sleeve.
- Receiver and antenna should be placed as far as possible from the controller, the batteries and power leads. Antenna should be placed as far as possible from lead strings and cable to tail.
- Connect the controller to throttle channel of your receiver.
- If you need to feed the receiver or servos from some other source carefully take out the central core of the servo cable connector. The taken out core of this conductor must be properly insulated.
- Use power conductors as short as possible – it is better for minimum weight and for minimum interferences.
- If motor runs in an opposite direction than desired, swap any two motor phases or change the revolution direction in the setting (page 2).
- **It is necessary to cool the controller in operation with flowing air. Do not prevent the cooling air to get to the controller (e.g. by packing it in foam).**
- **It is not allowed to feed the controller from any other source (such as mains power supply) than specified types of batteries !!!**
- **Do not disconnect the controller from batteries when motor runs or when it is still turning – that may lead to damage or destroyed of controller !!!**

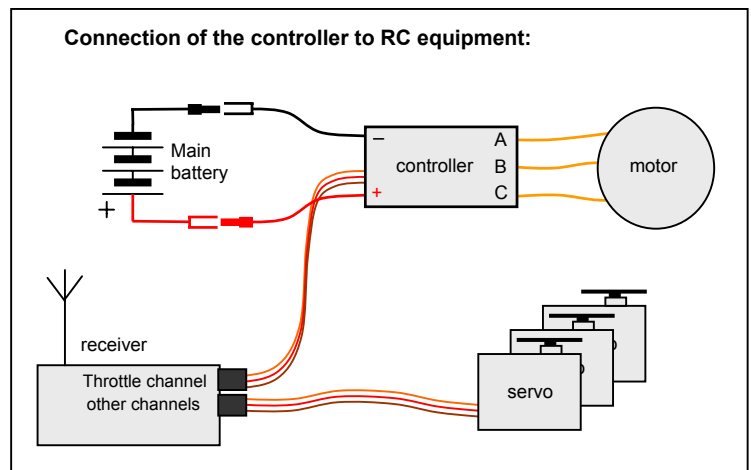

## SECURITY WARNING:

**Always disconnect the accumulators when not operating the model !!! Do not leave model with connected accumulators unattended !!! Please notice that running motor with propeller is very dangerous !!! Do not charge batteries when connected to the controller !!! If the controller is connected to batteries do not stay in the reach of the propeller !!**

- **NOTICE, reversal of poles on wires to the batteries will destroy the controller !** (This however, may not show immediately, but in some later starts or flights)
- **Short cut of these wires together (when batteries are connected) or short cut of these wires to the feeding voltage results in damage or destroy of the controller !**
- **Make sure that the motor is in a good condition. A faulty or damaged motor (mechanical damages, shortcuts on winding, etc.) may cause damage or destroy of the controller as well as the feeding cells.**

## 2) Start (go to air):





The controller is set automatically and meets the requirements of most users without any changes. This means that no programming is necessary, it is possible to go flying right after opening the package.

The controller is preset:

- **Lipol cells, number of cell sis determined automatically** (half charged and fully charged)
- **Automatic Timing** (sets optimal values for majority of factory manufactured motors) **for 2 to 20 pole motors of classical conception (rotor inside) and also for so called outrunners (rotor is on the outer side).**

If this setting does not suit you, see section 3 for description of settings change.

**The brake (switched off or on) is always set according the throttle stick position at the moment when the controller is switched on.**

<h3>Starting with the brake:</h3> <ol style="list-style-type: none"><li>1. switch the transmitter on</li><li>2. throttle down (min. throttle)</li><li>3. turn the controller ON</li><li>4. 1 × BEEP</li><li>5. you may start (max. throttle position is setup automatically)</li></ol> 	<h3>Starting without the brake:</h3> <ol style="list-style-type: none"><li>1. switch the transmitter on</li><li>2. full throttle (max. throttle)</li><li>3. turn the controller ON</li><li>4. 2 × BEEP</li><li>5. throttle down up to 10 sec.</li><li>6. 1 × BEEP</li><li>7. you may start</li></ol> 	<h3>Note:</h3> <p>If in the starting position of the throttle stick (min position), 2 × BEEP can be heard, change the norm of deflection of the throttle stick on the transmitter</p>  <p>If in the starting position of the throttle stick (max position), 1 × BEEP can be heard, change the norm of deflection of the throttle stick on the transmitter.</p> 
--	--	---

### 3) How to change settings of the controller:

If the preset setting does not suit you, the parameters can be changed. **All the settings is very simple and is done using transmitter and receiver** with which the controller will be used. No extra programming boxes are necessary. After programming the new parameters are permanently saved (until the next possible programming).

#### How to program the desired "value" in parameter you are setting (basic procedure in each parameter):

Move the throttle to ½ throttle, LED will be switched off 2x (twice) and motor beeps 2x. Move throttle back to min position, LED will be switched off once and motor beeps once. Repeat this procedure (½ throttle – min throttle) as many times as is the number of parameter (according to the table) you wish to set. **For example:** for setting the **number 3 in parameter B** (which is timing 15°) repeat the whole procedure (1/2 throttle – min throttle) **3x** (you certainly have to be in parameter B).

**The programming of each parameter will be finished** when you move the throttle from min position to the full throttle –LED will be turned off 3x and motor will beep 3x, then move the throttle back to min position, LED will be turned off 1x and motor will beep once – the parameter is programmed to the value you have chosen and saved (**this sequence is marked as "ENTER"**). This also automatically gets you to next parameter. After the last programmed parameter the controller must to be always switched off first !

**It is not obligatory to program all parameters** – it is possible to switch the controller off after any parameter which is correctly finished by ENTER sequence. The following parameters will not be changed and all the preceding will be saved.

**If you do not wish to change some parameter** (you wish to preserve its last value) you directly set full throttle when programming it (no ½ throttle – minimum procedure, but directly ENTER). The parameter value stay as it was before and the controller will get to the next parameter programming

**EASY return to default settings:** start the controller with full throttle as if you were going to program. After 10 seconds the controller will beep 3 times. Do not move the throttle to break position but wait another 5 seconds for 4 beeps. After those, move the throttle to break position (in 3 seconds) and the default setting is resumed and BASIC mode is set. If the throttle is not moved to break position in the 3 seconds time, the setting will not change and controller waits for switch off.

### The programming:

#### I) Turn the transmitter on with throttle stick in max position !

II) **Turn on the controller.** After 10 seconds the controller will beep 3 x and LED will blink and stay turned on. Now you have 3 seconds to move the throttle back to zero. If in this time limit you do not put the throttle in min position the programming process will end and the controller will be turned off. **Its next operation is possible after switching off and then turning on by disconnecting and connecting of batteries.** If you put the throttle to zero in this time limit the motor will beep 1x and the LED will be turned off 1x. Now you are in the programming mode and may start to program parameters according to the procedure described above.

#### III) Setup of parameters A to C:

According to „How to program the desired "value" in parameter you are setting" (see above), set the desired value of this parameter from 1 to 5 (look up in programming table). Now by using "ENTER" procedure (full throttle – min throttle) this parameter will be set and saved and you may proceed to program next parameter B and C. Parameters which you don't want change, skip by insert „ENTER". After programming the last desired parameter (C) **the programming is finish by performing ENTER.**

#### IV) Switch the controller off.

### Meaning of each parameter:

**Parameter A – batteries:** sets type of batteries – Lipol, Li-Ion or NiCd, NiMH.

*For a correct operation of the controller and for a reliable protection of batteries it is necessary to specify the type of cells. In the preset settings, use of Lipol (Li-Ion) cell sis expected. Therefore if you wish to use NiCd or NiMH cells, it is strongly recommended to change this parameter.*

**Parameter B – timing:** here you may choose 5 different timings include automatic timing.

Automatic timing is strongly recommended because it ensures optimal setting and maximal efficiency. While using the definite values of timing and higher timing you may rise the motor revolution or the twisting moment a bit but always at the expense of lowering the efficiency. If you wish to have higher revolutions it is better to use different motor or more cells because lower efficiency cannot be made up for. High value of timing may in unsuitable combination with some motors damage the controller !

*Motor with high inductance in rate to maximal current, for example some "LRK" motors, lots of motors from CD ROMs, etc.) setup timing 7,5° or 15°, automatic timing may not be optimal. The need of setting different timing can be easily recognized – motor looses synchronization for higher loads.*

**Parameter C – reverse:** This parameter sets a reversed direction of motor rotation without the need of swapping any two wires to motor.

#### Programming table:

Default setting is marked as **bold**

parameter	Value of parameter →	0 (= ENTER)	1	2	3	4	5
<b>A</b>	<b>Battery type</b>	next parameter	<u>Lipol</u>	NiCd, NiMH			
<b>B</b>	<b>Timing</b>	next parameter	<u>automatic</u>	7,5°	15°	22°	28°
<b>C</b>	<b>Reverse</b>	End of programming	<u>no</u>	yes	-	-	-

#### Examples:

##### A) Easy to fly. Brake ON, 3 Lipol cells, good motor:

- 1) Turn the transmitter on with throttle in **minimum position**.
- 2) Switch the controller ON, 1× motor beep and blinks once LED – **you may start**.
- 3) When you move throttle stick from minimum position, motor start. Maximal of throttle position is find automatically.
- 4) When you move throttle stick to minimum, motor is braking.

##### B) Programming. NiCd cells, timing setup to 15° (motor from CD ROM, no very good, with automatic timing lost synchronization):

- 1) Turn the transmitter on with throttle in max. position
- 2) After 10 seconds the controller will beep 3x and the LED will blink and stay lit. Move throttle to brake position, motor beeps once, Led blinks once – you have entered programming mode and you can program the first parameter A (see table)
- 3) Move the throttle to ½ of full throttle (idle position), LED blinks twice and motor beeps twice. Move throttle back to min position, LED blinks 1x and motor beeps. Repeat this once more (parameter A=2, it is NiCd / NiMH cells).
- 4) This setting has to be confirmed by ENTER sequence. Move throttle to full throttle position, LED blinks 3x and motor beeps 3x. Move throttle back to min position – LED blinks 1x and motor beeps 1x (= ENTER), aircraft mode has been set.
- 5) Move the throttle to ½ of full throttle (idle position), LED blinks twice and motor beeps twice. Move throttle back to min position, LED blinks 1x and motor beeps. (parameter B=1) Repeat this 2x and parameter B will be set to value 3 (B=3, that is timing 15°).
- 6) This setting has to be confirmed by ENTER sequence. Move throttle to full throttle position, LED blinks 3x and motor beeps 3x. Move throttle back to min position – LED blinks 1x and motor beeps 1x (= ENTER), aircraft mode has been set.
- 7) Because you do not wish to change following parameters, switch the controller off. Programming is finished.
- 8) After next controller on, you start with save new parameter values. **Brake on/off is set according the throttle stick position** at the moment when the controller is switched on.

# PROGRAMMING of the „easy xx“ controllers

## Setup (change) of the parameters

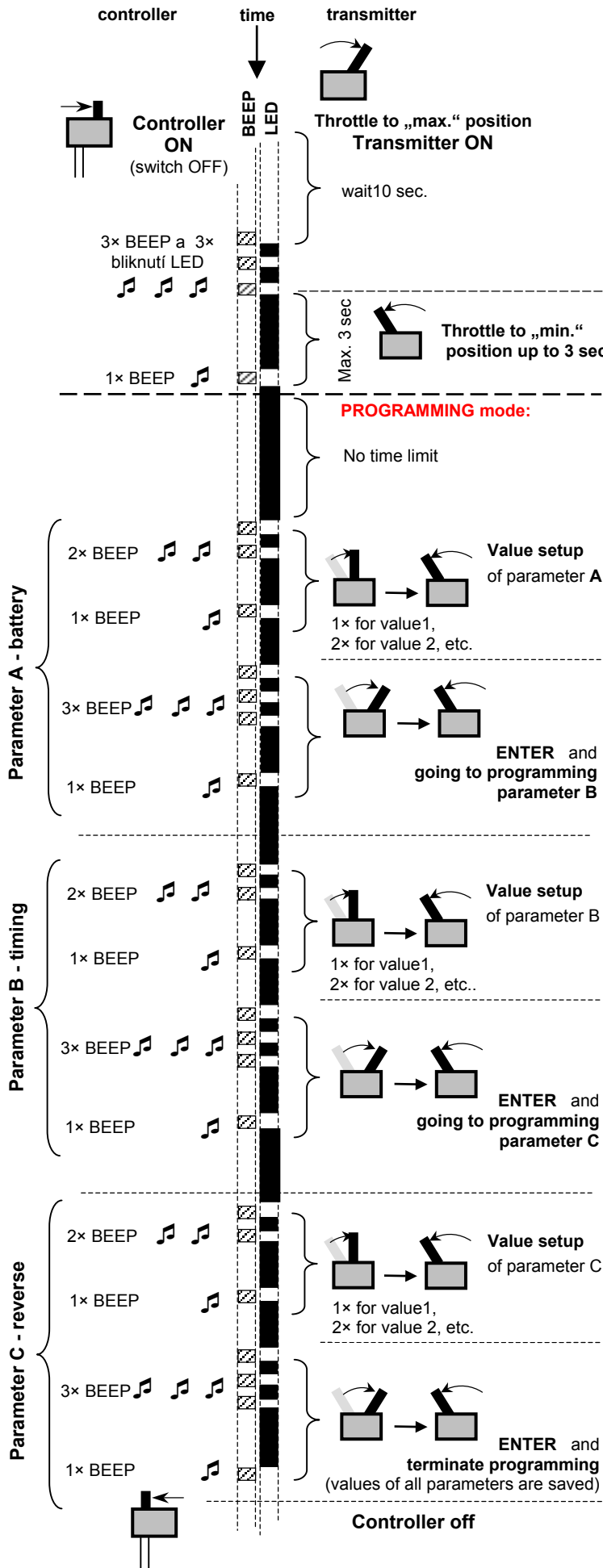

## Default parameters setup (factory parameters)

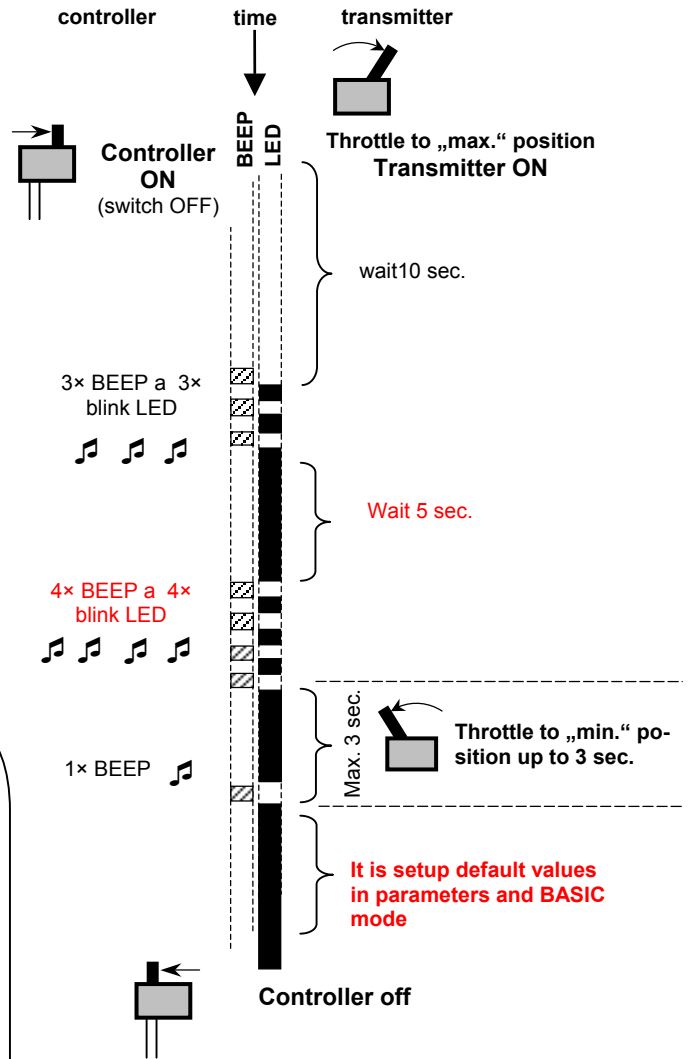

You can switch off the controller between steps (after ENTER) if you don't change next parameters.

All parameters that have already been confirmed by ENTER are now saved.

### Legend:

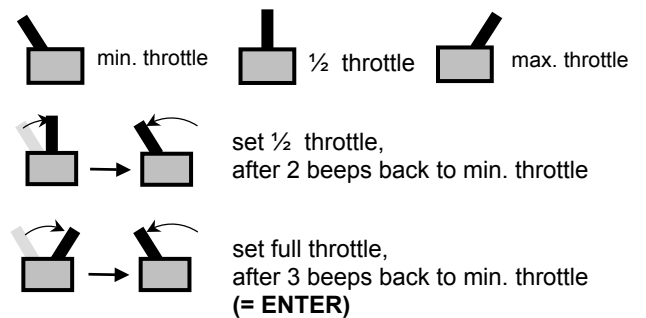

**Performance Characteristics:**

<b>Temperature of the environment:</b>	0°C to 40°C	<b>Number of regulation steps:</b>	1024 / full throttle
<b>Motor controlling:</b>	PWM 8 kHz	<b>Max. rpm for 2 poles motor:</b>	~170 000 rpm
<b>Control signal:</b>	positive pulses 1,5 ± 0,5 ms, period 10 ÷ 30 ms		
<b>BEC easy 7:</b>	5V / max. 1,5 A (power losses 2,5W continuous, 5W / 10 sec., 7W / 5 sec., no short circuit protection)		
<b>BEC easy 12 až 40:</b>	5V / max. 4,0 A (power losses 5W continuous, 10W / 10 sec., 15W / 5 sec., no short circuit protection)		
<b>Power supply:</b>	<b>from batteries only: Li-Ion, Lipol, NiCd, NiMH.</b> (use another power supply is restricted !)		
<b>Suitable for motors:</b>	Mega AC, Model Motors, MP JET, PJS, Überall model, Hacker, HCS, Kontronik, LRK, Plettenberg, etc.		

	easy 7	easy 12	easy 18	easy 25	easy 40
<b>Dimensions</b> (with external capacitor) [mm]:	22×18×4.5	25×23×6	42×27×6	46×27×6	57×34×6
<b>Weight incl. all conductors:</b>	5,5 g	9 g	17 g	21 g	35 g
<b>Weight without power conductors</b> (with servicable):	3,5 g	6 g	10 g	10 g	21 g
<b>No. of feeding Lipol / Li-Ion cells:</b>	2 – 3	2 – 3	2 – 4	2 – 4	2 – 4
<b>No. of feeding NiCd / NiMH cells:</b>	6 – 10	6 – 10	6 – 12	6 – 12	6 – 12
<b>Max. current for full throttle (peak 5 sec.):</b>	7 A (10A)	12 A (15A)	18 A (23A)	25 A (30A)	40 A (50A)
<b>No of standard servos for 2×Lipol / 3× Lipol / 4× Lipol:</b>	3 / 2 / –	5 / 4 / –	6 / 5 / 4	6 / 5 / 4	6 / 5 / 4

- Temperature fuse lowers the motor power to half when the temperature of the controller exceeds ~100°C.
- Current fuse switches the motor off when the allowed limits are exceeded. It is possible to start the motor back after throttling down to minimum.
- When voltage of batteries is almost empty, the controller starts to continuously reduce the motor revolutions.
- If the voltage of Lipol cells is lower than ~3,4V/cell (without load) at the moment of connection to the controller, the controller will not start the motor because the cells are almost discharged and it makes no sense to start (during the take-off, the little energy there was left could be soon exhausted, the motor power would be reduced and the model may crash)

The appearance and operating data may be changed without prior notice

**Error messages** (the controller must be switched off to correct error, then switched on again):

- throttle stick was moved the opposite way then it is supposed to (the thrtolle stick was not in the min or max position at the beginning, and after beep it was moved to the max or min position to which .... the throttle was closer and not the other (correct way)
- low size of deflection of the throttle stick on the transmitter – you must shorten the size of deflection on transmitter
- overstep max. throttle position 0,5 and 2,5 ms – you must shorten the size of deflection
- starting an overheated controller
- overheating of controller during operation (only LED blinks, motor does not beep, the power is reduced to 60%)
- more or less cells than specified
- current overload (resumes operation after dropping throttle to zero, it is not necessary to switch the controller off in this case)



- signal drop out for long time .....

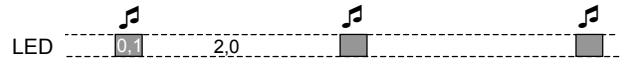

Numbers gives the approximate length of beep in seconds

**WARNING - You risk destroying the controller for:**

- connecting more battery cells to the controller than the max. number specified in the technical data
- reversing connections to the accumulator
- shortcutting of wires to motor when batteries are connected
- changing motor and accumulator outlets
- overloading of the BEC with bigger currents or bigger power loss than is specified in technical data
- water in the controller
- metal objects in the controller (screwdrivers, wires, etc.)
- disconnecting the controller from batteries or turning off the controller while motor is running (or still turning)

**Accumulators are protected** in four ways.

- 1) Firstly, due to the use of automatic current fuse (ACF) the possibility of current overload of accumulators (and their possible damage) even at crisis points is significantly reduced.
- 2) Secondly, the used system of intelligent power reduce (IPR) always ensures through measurements of number of voltage, currents, accumulator condition and calculations an optimal point of starting continuous reduction of motor performance (or the point when motor is switched off or point in which the motor power is reduced and then set back so that accumulator cells do not get extremely discharged – which is very important specially for Lipol cells.. This, not mentioning other advantages, reduces the possibility of reversal of poles of lower cells (applies mainly to NiCd / NiMH cells).
- 3) This system at the same time enables retaining defined energy for BEC, which is of great significance for flying models
- 4) the automatic current reduce (ACR) due to which a drop in voltage for BEC under extremely big current load (for every given controller) while motor starts does not occur.

**Using of Lipol cells:**

**Most controllers** designed for use with Lipol cells measure only voltage on the battery outlets. This is quite simple however also have several drawbacks. The real switching of voltage of these controllers is significantly influenced by the actual current and inner resistance of the cells. In one case (small currents, small inner resistances of batteries) the controller switches off too late (points M1 → M2) – and the cells may be easily undercharged and destroyed; In the other case (high currents, bigger inner resistance of batteries) the controller switches or starts to reduce power too early (points V1 → V2) even though the battery is not discharged (discharged only to 70%) – see graph a)

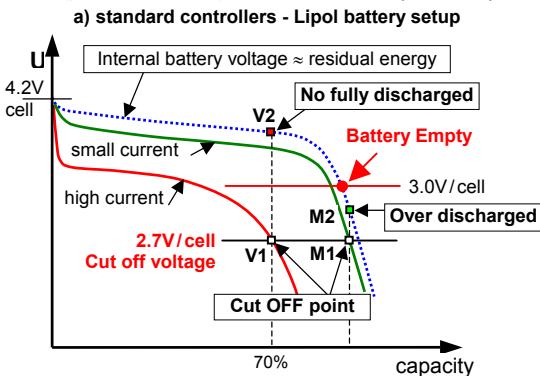

**The MGM compo controllers** (TMM line, easy line) take care of this problem and always switch off at the same inner voltage of cells (the same level of cells discharge) and this independently on the current and inner resistance of cells. This approach eliminates undercharging of cells as well as prevents early cut off or power reduction – graph b)

This approach is extremely significant for Lipol cells, as it undercharging of cells. Undercharging of cells always means deterioration of cells parameters or even cell destroy.

**b) MGM compo controllers**

