

I. FAST START in „Automatic limits“ mode for TRANSMITTERS with NEUTRAL throttle (with latched middle position of the throttle)

The controller is preset from the manufacture (default settings) to operation in „unidirectional boat“ and all important is set.

You do not have to programm or set anything.

If you however wish to operate the controller in „bidirectional boat“ mode, you have to set this mode – see „Programming“ part. If you wish to change the controller parameters, please refer to „Programming“ section.

Solder suitable connectors to the controller wires to batteries (red wire „plus“, black wire „minus“). The **overall length of wires between the batteries and the controller** should be **as small as possible**.

Yellow leads to the motor should be either soldered directly to the motor or it is possible to use suitable connectors.

Connect the servocable to the throttle channel of your receiver.

If you wish to enjoy all the possibilities of the controller, please refer to the whole manual.

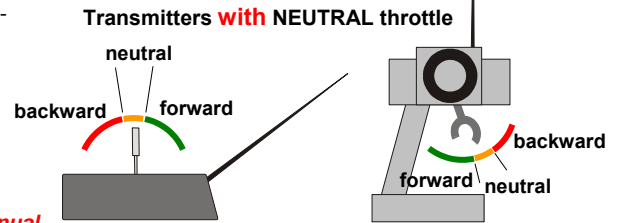

Start in „Automatic limits“ mode (default settings):

- 1a) switch the transmitter on in the „motor switched off“ position (= neutral).
- 1b) switch the controller on by connecting it to the **fully charged battery pack** for types with switch also with the switch (= disconnecting the contacts of the switch). **DO NOT REVERSE POLES !**
 If you have OPTO version of the controller, please remember to also connect the receiver battery !
- 1c) controller will make 1 short beep.

- 2a) Move the throttle to „maximal throttle forward“ position
- 2b) controller will make 3 short beeps

- 3a) move the throttle to „maximal throttle backwards“ position (in „unidirectional boat“ mode = motor off)
- 3b) controller will make 2 short beeps

- 4a) move the throttle to „NEUTRAL“ position
- 4b) controller will play a „melody“ or make 1 short beep *)

***) In the default settings „Automatic switching-off voltage“ is set so that the controller will play a „melody“.**
If you set type of cells, the controller will only beep 1x shortly.

- 5) **Do not turn the controller off, you may start riding immediately.**
 (if you do not wish to repeat the limits settings after each time you turn the controller on, set instead of „Automatic limits“ mode mode "Limits according to transmitter" in the programming (using transmitter, programming card or PC) and set the limits of your transmitter only once – see next page or section Programming)

- 6) Moving the throttle stick towards max. throttle forwards (gradually up to full throttle) you start the motor up and the model starts to move forward.

- 7) Moving the throttle stick back to **neutral** (or **max. throttle backwards**) you stop the motor.

Notice 1: If you wish to drive backwards you have to set „bidirectional boat“ mode.

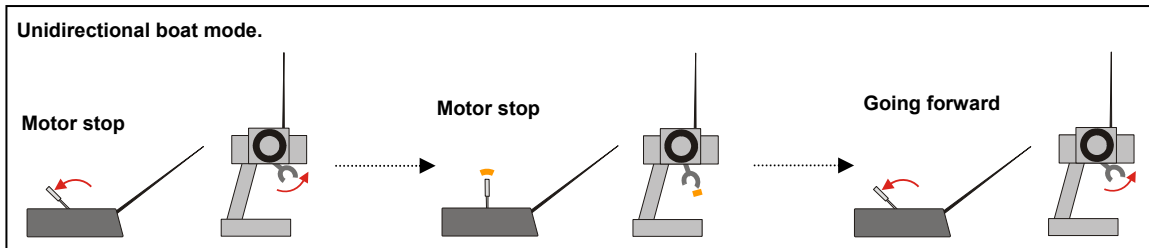

Notice 2: If the motor is turning in an opposite direction than you need (that is when moving the throttle forward the car moves backwards), swap any two yellow wires to the motor (to do this turn the controller off at first and disconnect the batteries) or change the settings in the controller, parameter „O“ (using the programming card or the transmitter) according to what is easier for you.

SECURITY WARNING:

Always disconnect the battery when not operating the model !!! Do not leave model with connected battery unattended !!! If the controller is connected to batteries do not stay in the area in front of the model ! Rotating screw can be very dangerous!!! Do not charge batteries when connected to the controller! Controller turned off by a switch only, draws small current from the batteries.

- **NOTICE, reversal of poles on wires to the batteries will reliably destroy the controller!** (The damage however, may not show immediately, but in some later rides!)
- **Short cut of these wires together** (when batteries are connected) or **short cut of these wires to the feeding voltage results in damage or destroy of the controller !**
- **Make sure that the motor is in a good condition. A faulty or damaged motor** (mechanical damages, shortcuts on winding, etc.) **may cause damage or destroy of the controller as well as the feeding cells.**
- **Disconnecting the connectors to battery or motor during operation** (motor is turning) **due to faulty or unsuitable connector leads to damage or destroy of the controller!**

II. FAST START in „Limits according to transmitter“ mode for TRANSMITTERS with NEUTRAL throttle
 (with latched middle position of the throttle):

The controller is preset from the manufacture (default settings) to operation in „unidirectional boat“ and all is set in the „automatic mode“. It is therefore necessary to set parameter E) to „Limits according to transmitter“ (E2), for more information see „Programming“ section.

If you use transmitter for programming, you will automatically „teach“ the controller the real limits of the throttle of your set (transmitter/receiver) and the following procedure step 1 to 5 may be stepped over and you may start with step 6a.

If you programm using UNICARD+ or PC start with step 1a.

If you wish to operate the controller in „bidirectional boat“ mode, you have to set this mode – see „Programming“ part. If you wish to change other the controller parameters, please refer to „Programming“ section.

Solder suitable connectors to the controller wires to accumulators (red wire „plus“, black wire „minus“). The overall length of wires between the batterie and the controller should be as small as possible. Yellow leads to the motor should be either soldered directly to the motor or it is possible to use suitable connectors. Connect the servocable to the throttle channel of your receiver.

If you wish to enjoy all the possibilities of the controller, please refer to the whole manual.

Setting the throttle limits (only for the first time and when you change transmitter/ receiver):

- 1a) switch the transmitter on in the „max throttle forwards“ position
- 1b) switch the controller on by connecting it to the fully charged battery pack for types with switch also with the switch (= disconnecting the contacts of the switch). **DO NOT REVERSE POLES !**
 If you have OPTO version of the controller, please remember to also connect the receiver battery !
- 1c) controller will make 3 short beeps 

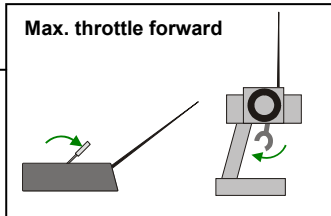

- 2a) wait for ca 10 seconds
- 2b) controller will make 3 long beeps 

- 3b) in 3 seconds time limit move the throttle to „maximal throttle backwards“

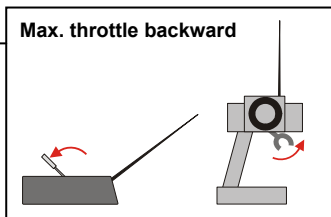

- 3b) controller will make 2 long beeps 

- 4a) move the throttle to „NEUTRAL“ position in 3 seconds time limit

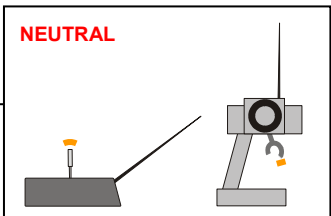



- 4b) controller will make 1 long beeps 

Notice. It is a classical procedure when programming using transmitter.

- 5) Turn the controller off, controller now knows its real throttle limits of your transmitter and remembers them.

Start in „Limits according to throttle“ mode (lets go riding):

- 6a) switch the transmitter on in the „motor switched off“ position (= neutral).
- 6b) switch the controller on by connecting it to the fully charged battery pack for types with switch also with the switch (= disconnecting the contacts of the switch). **DO NOT REVERSE POLES !**
 If you have OPTO version of the controller, please remember to also connect the receiver battery !
- 6c) controller will play a „melody“ or make 1 short beep *)  or 

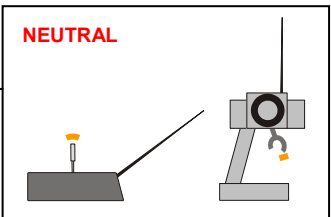

*) In the default settings „Automatic switching-off voltage“ is set so that the controller will play a „melody“. If you set type of cells (see section Programming), the controller will only beep 1x shortly.

- 7) You may start riding.

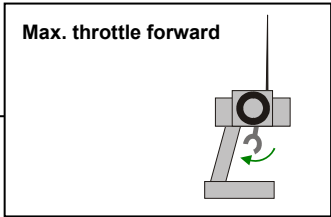

- 8) Moving the throttle stick towards max throttle forwards (gradually up to full throttle) you start the motor up and the model starts to move forward.

- 9) Moving the throttle stick back to neutral (or max. throttle backwards) you stop the motor.

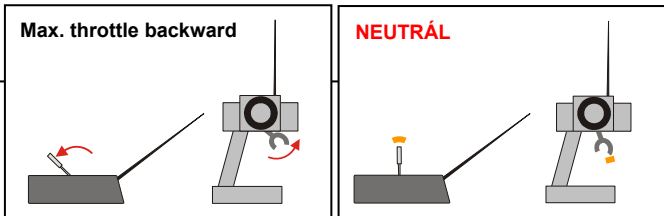

Notice 1: If you wish to drive backwards you have to set „bidirectional boat“ mode.

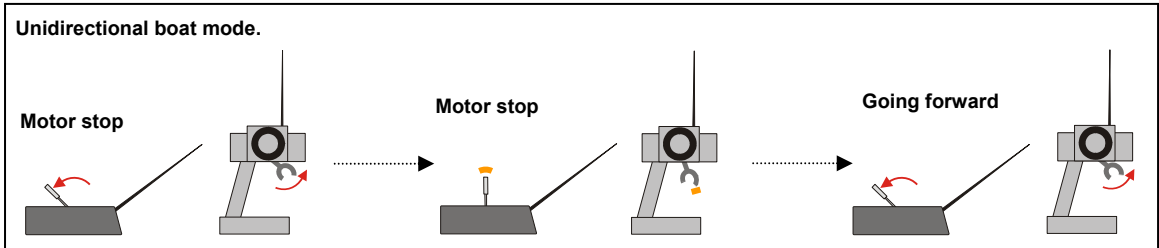

Notice 2: When „unidirectional mode“ is set, in steps 9) the boat will not move backwards.

Notice 3: If the motor is turning in an opposite direction than you need (that is when moving the throttle forward the car moves backwards), swap any two yellow wires to the motor (to do this turn the controller off at first and disconnect the batteries) or change the settings in the controller, parameter „O“ (using the programming card or the transmitter) according to what is easier for you.

III. FAST START in „Automatic limits“ mode for TRANSMITTERS without NEUTRAL throttle (applies only for „unidirectional boat“ mode)

The controller is preset from the manufacture (default settings) to operation in „unidirectional boat“ and all is set in the „automatic mode“. **You do not have to programm or set anything.**

If you however wish to operate the controller in „unidirectional boat“ (A4) mode, you have to set this mode (using transmitter, card or PC) – see „Programming“ part. You do not have to programm or set anything else.

Solder suitable connectors to the controller wires to batteries (red wire „plus“, black wire „minus“). The overall **length of wires between the battery and the controller should be as small as possible.** Yellow leads to the motor should be either soldered directly to the motor or it is possible to use suitable connectors.

Connect the servocable to the throttle channel of your receiver.

Transmitters without NEUTRAL

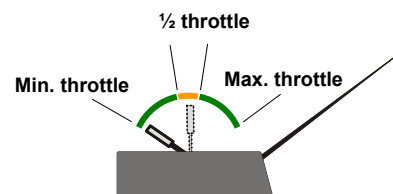

If you wish to enjoy all the possibilities of the controller, please refer to the whole manual.

Start in „Automatic limits“ mode (default settings):

1a) witch the transmitter on in the „minimal throttle“ position (motor turned off).

1b) switch the controller on by connecting it to the **fully charged battery pack** for types with switch also with the switch (= disconnecting the contacts of the switch).

DO NOT REVERSE POLES !

If you have OPTO version of the controller, please remember to also connect the receiver battery !

1c) controller will make 1 short beep. 🎵

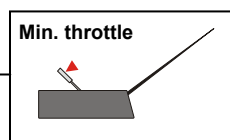

2a) move the throttle to „maximal throttle forward“ position

2b) controller will make 3 short beeps 🎵🎵🎵

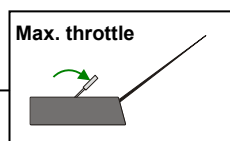

3a) move the throttle to „motor turned off“ position (=minimal throttle)

3b) controller will play a „melody“ or make 1 short beep *) 🎵🎵🎵 or 🎵

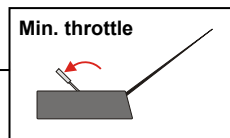

***) In the default settings „Automatic switching-off voltage“ is set so that the controller will play a „melody“. If you set type of cells, the controller will only beep 1x shortly.**

4) **Do not turn the controller off, you may start riding immediatelly.**

(if you do not wish to repeat the limits settings after each time you turn the controller on, set instead of „Automatic limits“ mode mode "Limits according to transmitter" in the programming(using transmitter, programming card or PC) and set the limits of your transmitter only once – see next page or section Programming)

5) Moving the throttle stick towards max throttle forwards (gradually up to full throttle) you start the motor up and the model starts to move forward.

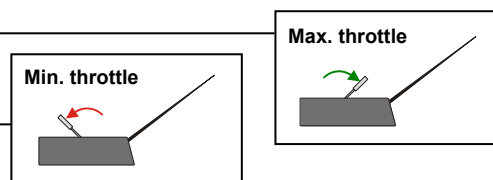

6) Moving the throttle back to minimal throttle lowers the motor resolutions.

Notice 3: If the motor is turning in an opposite direction than you need(that is when moving the throttle forward the car moves backwards), swap any two yellow wires to the motor (to do this turn the controller off at first and disconnect the batteries) or change the settings in the controle, parameter „O“ (using the programming card or the transmitter) according to what is easier for you.

SECURITY WARNING:

Always disconnect the battery when not operating the model !!! Do not leave model with connected battery unattended !!! If the controller is connected to batteries do not stay in the area in front of the model ! Rototating screw can be very dangerous!!!
Do not charge batteries when connected to the controller! Controller turned off by a switch only, draws small current from the bytteries.

- **NOTICE, reversal of poles on wires to the batteries will reliably destroy the controller!** (The damage however, may not show immediatelly, but in some later rides!)
- **Short cut of these wires together (when batteries are connected) or short cut of these wires to the feeding voltage results in damage or destroy of the controller !**
- **Make sure that the motor is in a good condition. A faulty or damaged motor (mechanical damages, shortcuts on winding, etc.) may cause damage or destroy of the controller as well as the feeding cells.**
- **Disconnecting the connectors to battery or motor during operation (motor is turning) due to faulty or unsuiable connector leads to damage or destroy of the controller!**



IV. FAST START in „Limits according to transmitter“ mode for TRANSMITTERS without NEUTRAL throttle (applies only for „unidirectional boat“ mode):

The controller is preset from the manufacture (default settings) to operation in „unidirectional boat“ and all is set in the „automatic mode“.

You do not have to programm or set anything else.

However, you it is necessary to set parameter E to „Limits according to transmitter“ (E2), for more information see „Programming“ section.

If you use transmitter for programming, you will automatically „teach“ the controller the real limits of the throttle of your set (transmitter/receiver) and the following procedure step 1 to 5 may be stepped over and you may start with step 6a.

If you programm using UNICARD+ or PC start with step 1a.

If you wish to change other the controller parameters, please refer to „Programming“ section.

Solder suitable connectors to the controller wires to accumulators (red wire „plus“, black wire „minus“). The **overall length of wires between the batteries and the controller should be as small as possible**. Yellow leads to the motor should be either soldered directly to the motor or it is possible to use suitable connectors.

Connect the servocable to the throttle channel of your receiver.

If you wish to enjoy all the possibilities of the controller, please refer to the whole manual.

Setting the throttle limits (only for the first time and when you change transmitter/ receiver):

- 1a) switch the transmitter on in the „max. throttle“ position
- 1b) switch the controller on by connecting it to the **fully charged battery pack** for types with switch also with the switch (= disconnecting the contacts of the switch). **DO NOT REVERSE POLES !**
If you have OPTO version of the controller, please remember to also connect the receiver battery.

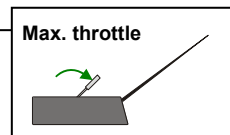

- 1c) controller will make 3 short beeps

- 2a) wait for ca 10 seconds
- 2b) controller will make 3 long beeps

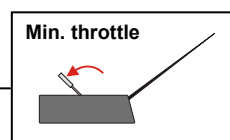

- 3a) move the throttle to „minimal throttle“ position

- 3b) controller will make 2 long beeps

- 4) Wait **longer than 3 seconds**, the controller will make 1 long beep

Notice. It is a classical procedure when programming using transmitter.

- 5) **Turn the controller off**, controller now knows its real throttle limits of your transmitter and remembers them.

Start in „Limits according to throttle“ mode (lets go riding):

- 6a) switch the transmitter on in the „minimal throttle“ position (=motor turned off).
- 6b) switch the controller on by connecting it to the **fully charged battery pack** for types with switch also with the switch (= disconnecting the contacts of the switch). **DO NOT REVERSE POLES !**
If you have OPTO version of the controller, please remember to also connect the receiver battery.
- 6c) controller will play a „melody“ or make 1 short beep *)

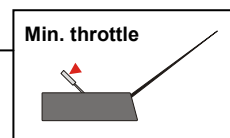

***) In the default settings „Automatic switching-off voltage“ is set so that the controller will play a „melody“.**
If you set type of cells (see section Programming), the controller will only **beep 1x shortly**.

- 7) You may start riding.

- 8) Moving the throttle stick towards max. throttle forwards (gradually up to full throttle) you start the motor up and the model starts to move forward.

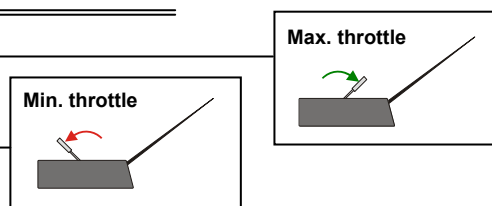

- 9) Moving the throttle back to minimal throttle lowers the motor resolutions.

Notice 3: If the motor is turning in an opposite direction than you need (that is when moving the throttle forward the car moves backwards), swap any two yellow wires to the motor (to do this turn the controller off at first and disconnect the batteries) or change the settings in the controller, parameter „O“ (using the programming card or the transmitter) according to what is easier for you.

SECURITY WARNING:

Always disconnect the battery when not operating the model !!! Do not leave model with connected battery unattended !!! If the controller is connected to batteries do not stay in the area in front of the model ! Rototating screw can be very dangerous!!! Do not charge batteries when connected to the controller! Controller turned off by a switch only, draws small current from the bytteries.

- **NOTICE**, reversal of poles on wires to the batteries will reliably destroy the controller! (The damage however, may not show immediately, but in some later rides!)
- **Short cut of these wires together** (when batteries are connected) or **short cut of these wires to the feeding voltage results in damage or destroy of the controller !**
- **Make sure that the motor is in a good condition. A faulty or damaged motor** (mechanical damages, shortcuts on winding, etc.) **may cause damage or destroy of the controller as well as the feeding cells.**
- **Disconnecting the connectors to battery or motor during operation** (motor is turning) **due to faulty or unsuitable connector leads to damage or destroy of the controller!**



TMM® xxxx - 3 RACE BOAT E3-series / Z3-series range controllers are bidirectional / unidirectional, outstanding fully programmable controllers for "brushless" sensorless and sensor motors (BLCD motors) for models of racing boats, submarines etc., manufactured in several modifications and variants, see further.

They take up on the successful preceding series of Race Boat Expert controllers and Z-series controllers. The difference between the new Z3 series and the new E3 series is that Z3 supports connection to Black Box and thus enable to record the whole ride in detail, which is not possible with E3. All other features are quite similar. Great attention is paid to the continuous development which is considered to be the key issue in order to provide customers with the newest, preferred features and up to date controllers. To enable our customers to exploit the newest developments, SW update can be carried out by the customer itself through the internet. The quality is being continuously watched in the manufacture. Each controller passes a series of tests. The final test of each controller is done under its full load.

New features of the controllers:

- new** - you can update the controller with a newer and current SW version yourself from www.mgm-compro.com, using your PC, USBCOM++ module and CC_03 cable. This new feature is very useful and favorable. Controller may have additional features that were not available at the time of purchase. You may have actual version at all times.
- new** - currents are measured and recorded with significantly higher accuracy than is usual
- new** - higher power types (HP) are much more resistant to destroy by excessive currents
- new** - they support also motors with higher working frequency (such as motors „Mamba“, „Tango" by Kontronik etc.)
- new** - some types (marked as LV) work from very low voltages (3.5V) – that is starting at 4 Nixx cells or 2 A123 cells
- new** - Z3 controllers together with Black Box record the real speed of your car and its acceleration → optimal tuning of the drive and chassis which is unique and unmatched feature
- new** - controllers support Nixx, Lipol / Li-Ion, A123 cells and possibly any other new battery type (universal settings) which may have not even existed at the time of the controller production
- new** - it is possible to reduce power also in reverse gear
- new** - two types of Race modes (current and voltage fuses are inactive / only current fuse is inactive)
- new** - no programming is necessary, however who wishes to set the drive unit optimally has a choice of much more setting possibilities
- new** - some types also support sensor motors (marked SE)
- new** - they may measure and watch also motor temperature (external motor sensor or integrated sensor in sensor motors), applies only to SE versions for sensor motors.

Other advantages:

- the possibility of easy settings and modification of whole range of parameters and features using transmitter, or PC and USBCOM++ or programming card UNICARD+. Setting is done using ICS connector – it is not necessary to take out servocable from receiver.
- unmatched protection and management of batteries Lipol / Lion (here it is of a fundamental importance) as well as A123 cells and NiCd / NiMH
- possibility of reading out important data measured during the controller operation using PC
- very smooth starts with sensor as well as sensorless motors
- extremely fine throttle step 1024 values (steps)
- unidirectional as well as bidirectional operation
- extremely powerful BEC (switched "S BEC"), with choice of 5V or 6V and currents up to 6A
- version with a switch is manufactured as well (in safe connection – damage of switch does not affect controller)
- it is possible to choose from several types of completion and cooling, not only water cooling (standardly) but also cooling by air, together with active cooling using a fan.

Basic recommendations:

- **! Shorten the conductors between the battery and the controller as much as possible (however not under 3cm, there is a possibility of unsoldering wires from the controller) ! The higher the power and the "faster" the used motor, the more important is this requirement!**
- if you need to prolong the power conductors to batteries (distance between the controller and the batteries > 20 cm), it is necessary to solder additional capacitors (same as in the controller) as close to the controller (to "+" and "-" conductors of the controller) as possible. The capacitors must be "very low ESR", 105°C with at least double the capacity than those used in the controllers. It is strongly discouraged to prolong the overall length of conductors between the battery and the controller above 15 – 20 cm for currents above 80A.
- use only quality and well dimensioned connectors, such as MP JET 1.8 – 2.5 – 3.5 – 5.5 – 6.0 mm which are dimensioned for currents up to 200 – 300A.
- remember to properly cool the controller by water, specially when working near its limit parameters or choose types with external coolers (possibly also with a fan).
- one controller can control only one motor.
- you do not have to do any settings on the controller at all, however if you wish to optimally exploit its features, we recommend to program it - see section "Programming".

It is recommended to measure current drawn from accumulators (preferably using clamp A-meter!) with a particular motor and speed ratio for correct dimensioning of the controller. It is convenient to use measurements carried out by the controller during the drive and their display using PC. Please remember, that even one additional cog on pinion of the motor significantly increase the drawn currents. With acceleration set faster, currents in the start-up peak rise very fast, and that up to many times of the current in the steady state. It is necessary to do the measurement with the hardest batteries, which you wish to use in the set. This will prevent possible problems with overloading the controller, motor and batteries.

Connecting the controller:

- Opposite piece of the connector, which is on your battery, should be soldered to the leading-in conductors to the battery. Use only quality golden plated kinds. Recommended are connectors MP JET 1.8 – 2.5 – 3.5 – 5.5 – 6.0 mm according to the type of controller and current. MP JET connectors feature small transition resistance, small dimensions and very firm connection (they do not come apart themselves as some other types do). We recommend to put the socket on the "-" wire (black wire) of the controller and the plug on the "+" wire (red wire).
- Receiver and antenna should be placed as far as possible from the controller, the batteries and power leads.
- **NOTICE, reversal of poles on wires to the batteries will reliably destroy the controller!** (The damage however, may not show immediately, but in some later starts or flights!)
- The leads to the motor (yellow wires marked "A", "B", "C") should be soldered directly to the motor or it is also possible to use the connectors mentioned above. If you decide to use connectors, this time solder sockets to the controller leads.
Short cut of these wires together (when batteries are connected) or short cut of these wires to the feeding voltage results in damage or destroy of the controller !
- Insulate the connectors after soldering, e.g. using heat shrinking sleeve!
- Use power conductors as short as possible – it is the best for minimum weight as well as for lowering losses and possible interference. Do not make them shorter than 3 cm – possibility of unsoldering wires from the controller.
- Connect the controller to throttle channel of your receiver.
- If motor runs in an opposite direction than desired, swap any two motor phases or change the revolution direction in the settings of the controller.
- Controller warns of overload and overheating acoustically (motor beeping) as well as by indicating LED.
- It is not allowed to feed the controller from any other source (such as mains power supply) than specified types of batteries!!!
- The controller switch is connected so that drop-out of BEC voltage is not possible if the switch fails (safe connection).
- Controller is turned on by TURNING OFF the switch (applies to controllers "s" version with a switch) or by connecting the batteries (applies to versions without the switch).
- Do not SWITCH OFF or DISCONNECT the controller from batteries or motor when motor RUNS or when it is still turning – that may lead to damage or destroy of the controller !!! This also applies to spontaneous disconnecting of the connector during operation, eg. by vibrations!!! This is why

connectors should be chosen very carefully. MP JET 2.5 - 3.5 - 5.5 - 6.0 mm are recommended, or a similarly quality ones. Connectors of „plug“ type 4mm), even golden-plated (4mm Gold Plated Bullet Connectors) or connectors of „Dean“ type are discouraged for use.

Connection of the controller to the RC equipment:

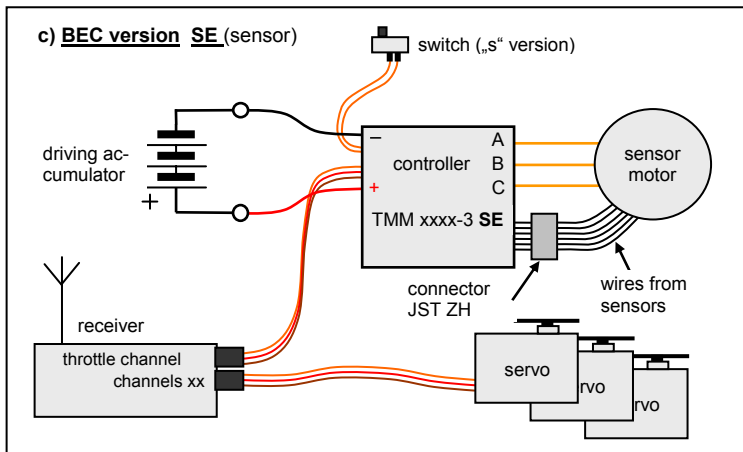
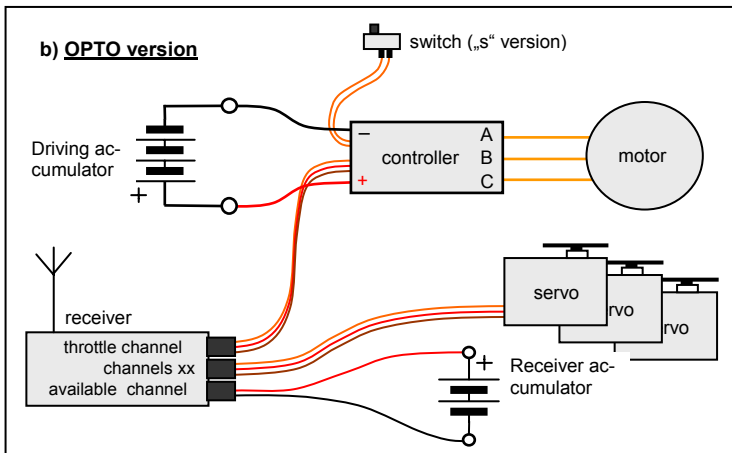
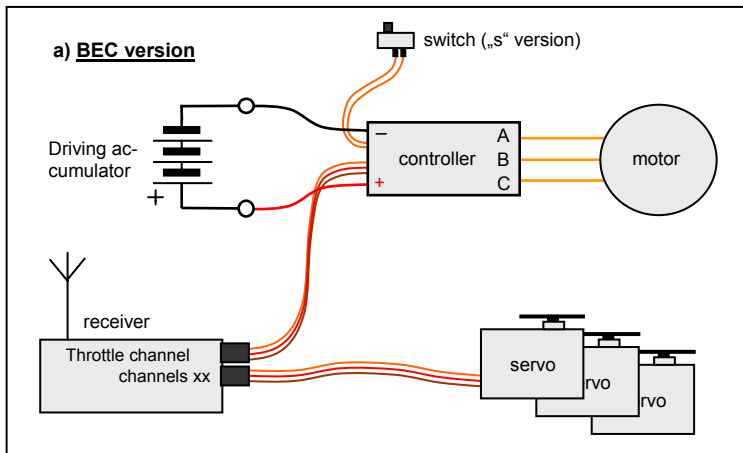

Notice:
(only for versions with BEC!!!)
 If you need to feed the receiver or servos from some other source than BEC, carefully take out the central core of the servo cable connector (red wire) and insulate it properly.



With OPTO versions DO NOT TAKE OUT the core!!!

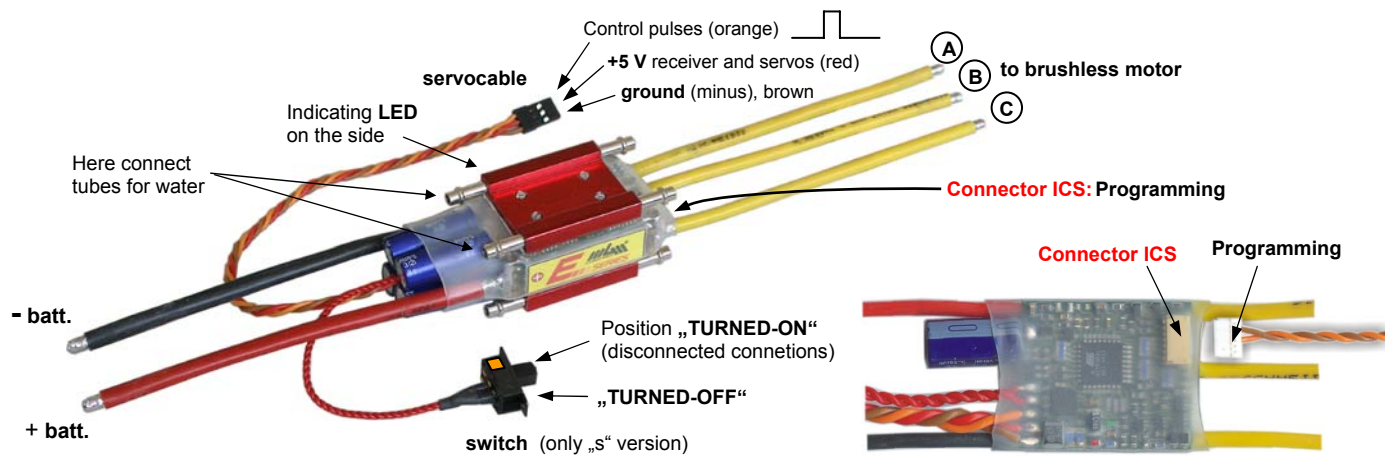

SECURITY WARNING:
Always disconnect the battery when not operating the model !!! Do not leave model with connected battery unattended !!! If the controller is connected to batteries do not stay in the area in front of the model ! Rotating screw can be very dangerous!!!
Do not charge batteries when connected to the controller! Controller turned off by a switch only, draws small current from the batteries.

- **NOTICE**, reversal of poles on wires to the batteries will reliably destroy the controller! (The damage however, may not show immediately, but in some later rides!)
- **Short cut of these wires together (when batteries are connected) or short cut of these wires to the feeding voltage results in damage or destroy of the controller !**
- **Make sure that the motor is in a good condition. A faulty or damaged motor (mechanical damages, shortcuts on winding, etc.) may cause damage or destroy of the controller as well as the feeding cells.**
- **Disconnecting the connectors to battery or motor during operation (motor is turning) due to faulty or unsuitable connector leads to damage or destroy of the controller!**

1) Controller SW update (firmware):

If you wish to update SW of your controller with the newest available version, you need **USBCOM++** version 3.10 or higher and connection cable **CC_03**. Then follow the instructions on our website www.mgm-compro.com . Press „**SW UPDATE**“ button in the main menu to enter the SW update page.

2) Programming / reading out data from controller using PC:

If you wish to program the controller using PC or read out some values from the controller, it is necessary to connect the controller with your PC using USBCOM++ module, SW which is supplied together with the communication module and available for download on website, and a connection cable CC_02.

Programming using PC will make the parameter setting of your controller easier and more clear. Reading out values will help with determining the optimal dimensioning of your drive so that you would on one side exploit power and technical possibilities of your controller / motor / batteries and on the other prevent overloading of these devices/components. When programming controllers with BEC keep your transmitter turned on – servos will not jerk after turning the controller on.

For installation, reading out data from the controller and programming the controller follow the instructions in the manual of your USBCOM++ module and in the manual „Programming with USBCOM++“.

Overview of read out data from the controller:
(measured during the last ride)

- maximal average current
- aximal peak current
- end voltage of accumulators (when turning the controller off)
- maximal temperature of the controller
- throttle max. position backward
- throttle neutral position
- throttle max. position forward
- maximal motor revolutions

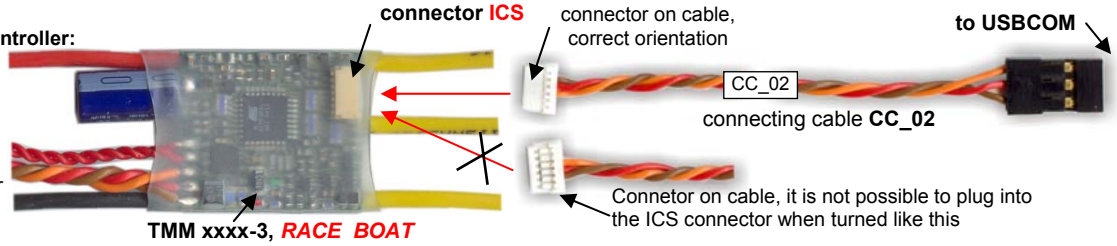

Control window on PC:

Type and version of the controller are recognized automatically.

min. (full throttle backward) and max. (full throttle forward) throttle position + neutral – read out / change of value

Setting number of poles and gear ratio

Measured values area

If you have a Z-series controller, you may connect it with Black Box “BB_03” and save data during the ride. In such case you will get values and graphs of not only currents, voltages, revolutions etc. Follow the instructions to BB_03 manual.

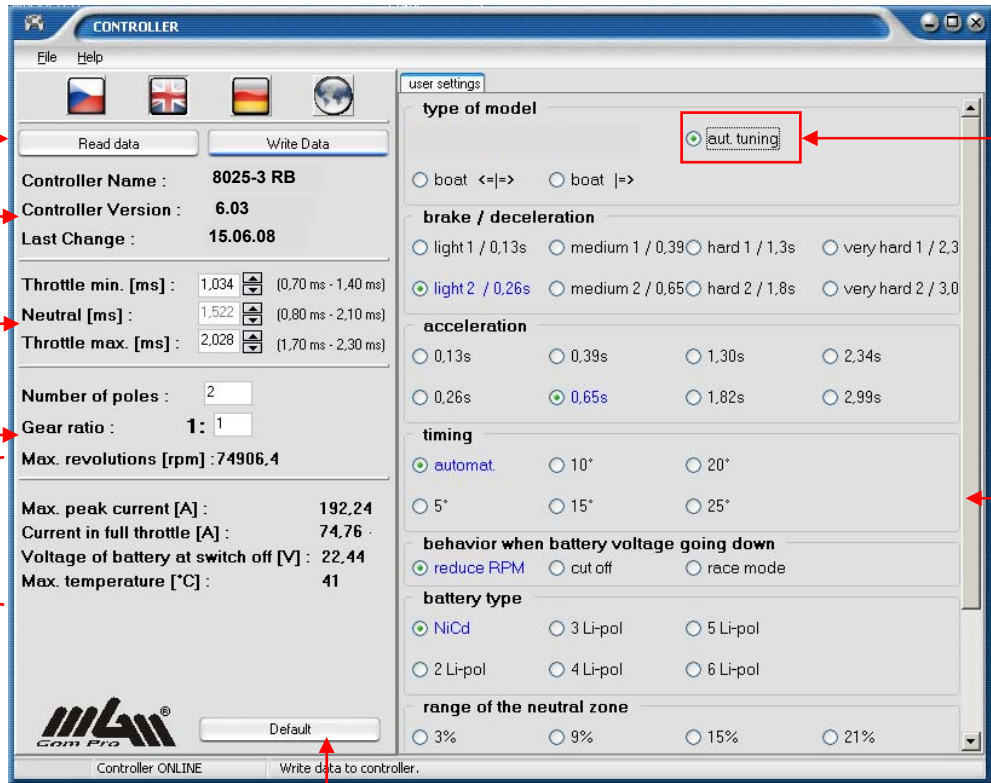

Setting „Motor Tuning“

Shift to other parameters hidden below

Quick setting of default parameters

Parameters read out from controller are displayed here+changes of parameters can be done here using mouse

3) Programming the controller using UNICARD+:

All parameters may be easily set using the programming card UNICARD+, (version 3.00 and higher). Choose „RACE BOAT“ E-series or Z-series tag marked "for controller with SW version 6.00 and higher". Connect the card with the controller through ICS connector using CC_02, it is not necessary to disconnect the controller from receiver during programming. When programming controllers with BEC keep your transmitter turned on – servos will not jerk after turning the controller on.

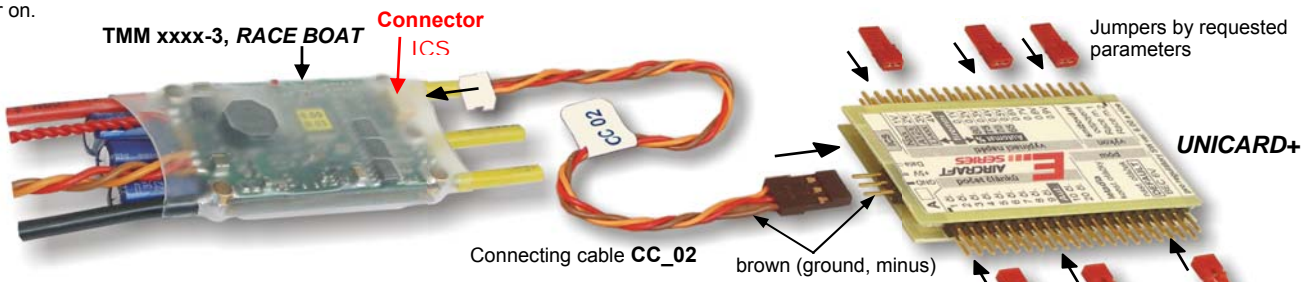

For more detail instructions see the uncard instructions for use.

Recommended procedure for programming using UNICARD+ or PC:

If you set „Limits according to transmitter“ (so that you do not have to set the limits of transmitter after each switch on of the controller) mode, you have to set the real limit positions of your RC set - your transmitter with receiver - the easiest way to do this is to start the programming procedure using transmitter. You do not have to set any parameter, it is enough to enter the programming mode – the marked by yellow line beginning of programming, for details see section 4) „Programming“ or “Quick Start“.

4) Programming the controller using transmitter:

If the default setting of the controller does not suit your needs from any reason, it is possible to change any of the programmable parameters. All settings may also be done **using transmitter and receiver**. Nothing has to be disconnected and no connections have to be changed.

Programming – for TRANSMITTERS with NEUTRAL throttle (with latched middle position of the throttle):

- Turn the transmitter on with the throttle stick in max. forward position.

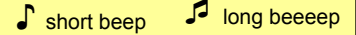

- Turn the controller on. Controller shortly beeps 3x, after 10 seconds 3x long beeps will be heard. You now have 3 seconds to move the throttle to max. throttle backwards.

If in this time limit you do not put the throttle in min position the programming process will skip to the possibility of setting the default settings (see below), will end and the controller will be turned off. Its next operation is possible after switching off and then turning it on again.

If in this time limit of 3 seconds you move the throttle to max. throttle backward position, controller will make 2 long beeps. Move throttle to neutral, controller makes 1 long beep and you have **entered the programming mode**.

Now you may start to program parameters according to the procedure described below, with no time limits.

If you wish to only set limits (max. forward, max. backwards and neutral position) according to the transmitter (for „Limits according to transmitter“ mode), you may switch the controller off now, limits have been saved.

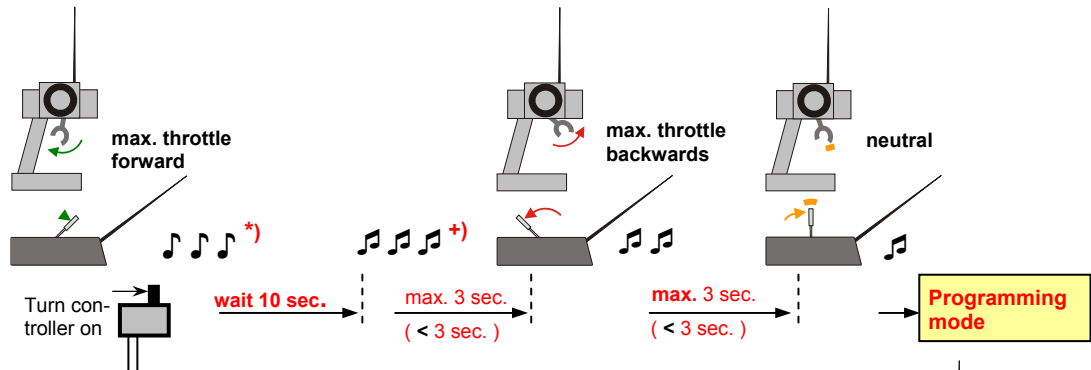

***) If anything else than 3x short beeps are heard, reverse the deflections of the throttle channel on your transmitter!**

+) If after 10 seconds 3 long beeps are not heard, enlarge the deflections of the throttle change on your transmitter!

- Setting requested „value“ of a parameter in the programming mode (basic procedure for setting of each parameter).

Initial throttle stick position is in neutral. Move the throttle stick to „max. throttle backwards“ position, motor beeps 2x. Move the throttle back to neutral, motor beeps 1x. Repeat this procedure (max. throttle backwards [=full brake] – neutral) as many times as is the value of the parameter - according to the table – which you wish to set.

For example to set value 3 in parameter „C“ (that is Lipol cells) repeat the procedure (max. throttle backwards – neutral) 3x. Certainly, you have to be in this particular parameter already.

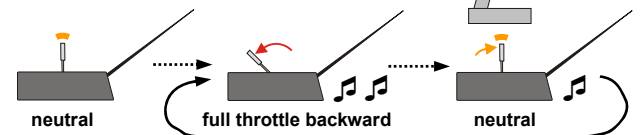

- Programming of each parameter will be finished when you move the throttle from neutral to the „full throttle forward“ – motor will produce 3 long beeps. Move the throttle back to neutral, motor beeps 1x long. **This sequence is called „ENTER“**. Parameter has been programmed to the chosen value and is now saved. This automatically moves you to the next parameter, which value may be set according to the previous paragraph. The procedure will allow you to set all parameters one after another.

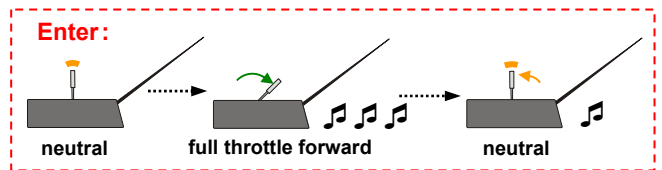

- After the last programmed parameter and completing „ENTER“ the controller must be switched off, which finishes the programming.

Programming – TRANSMITTERS without NEUTRAL throttle (applies only for „unidirectional boats“ mode):

- Turn the transmitter on with the throttle stick in max position.

- Turn the controller on. Controller shortly beeps 3x, after 10 sec. 3x long beeps will be heard ***)**. Now you have 3 seconds to move the throttle back to minimum.

If in this time limit you do not put the throttle in min position the programming process will skip to the possibility of setting the default settings (see below), will end and the controller will be turned off. Its next operation is possible after switching off and then turning it on again.

If in this time limit of 3 seconds you move the throttle to min. position, controller makes 2 long beeps. Wait for **at least 3 seconds**, controller will make 1 long beep and you have **entered the programming mode**. Now you may start to program parameters according to the procedure described below, with no time limits.

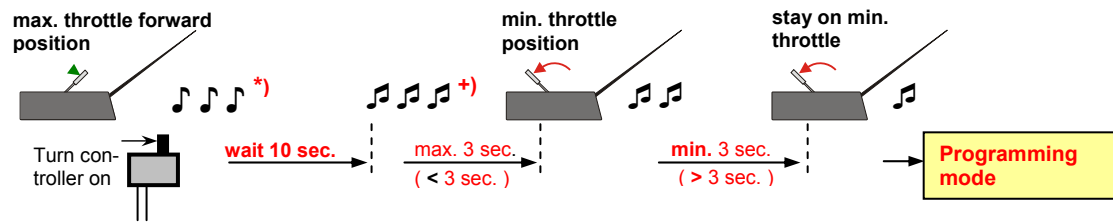

If you wish to only set limits (min. and max. positions) according to the transmitter (for „Limits according to transmitter“ mode), you may switch the controller off now, limits have been saved.

***) If anything else than 3x short beeps are heard, reverse the deflections of the throttle channel on your transmitter!**

+) If after 10 seconds 3 long beeps are not heard, enlarge the deflections of the throttle change on your transmitter!

- Setting requested „value“ of parameters (basic procedure for setting in each parameter).

Initial throttle stick position is in minimal throttle. Move the throttle stick to approximately „½ throttle“, motor beeps 2x. Move the throttle back to min. position, motor beeps 1x. Repeat the procedure (½ throttle – minimal throttle) as many times as is the value of the parameter - according to the table – which you wish to set. For example for setting value 3 in parameter „C“ (that is Lipol cells) repeat the procedure (½ throttle – minimal throttle) overall 3x. Certainly, you have to be in this particular parameter already.

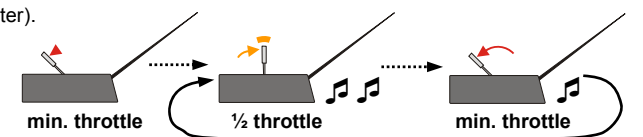

- Programming of each parameter will be finished when you move the throttle from min. position to „full throttle“ – motor will produce 3 long beeps. Move the throttle back to minimal position – you will hear 1 long beep (**this sequence is called „ENTER“**) – parameter is now set to the chosen value and saved. This automatically moves you to the next parameter, which value may be set according to the previous paragraph. The procedure will allow you to set all parameters one after another.

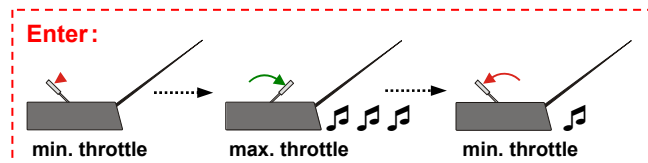

- After the last programmed parameter and completing „ENTER“ the controller must be switched off, which finishes the programming.

5) Notes to programming:

It is not obligatory to program all parameters, it is possible to switch the controller off after any parameter which is correctly finished by the „ENTER“ sequence. The following parameters will not be changed and all the preceding ones will be saved.

If you do not wish to change some parameter (you wish to keep its last value), set "ENTER" directly when programming it. The last saved value will be kept for the parameter and the controller will get to the programming of the next parameter.

EASY return to the default settings:

Turn the controller on with **full throttle forward** (max. throttle for transmitters without neutral) as if you were going to program it. Controller will make 3 short beeps. After 10 seconds 3 long beeps will be heard. Do not move the throttle back to minimum, but **wait for another 5 seconds for 4 short beeps**. If you now (after the 4 beeps) move the throttle back to **maximal throttle backwards** (minimal position for transmitters without neutral) during 3 seconds time limit, the controller beeps 1x and the **default parameters are set**. If the throttle is not moved back, nothing is changed in the settings, and the controller waits for switch off.

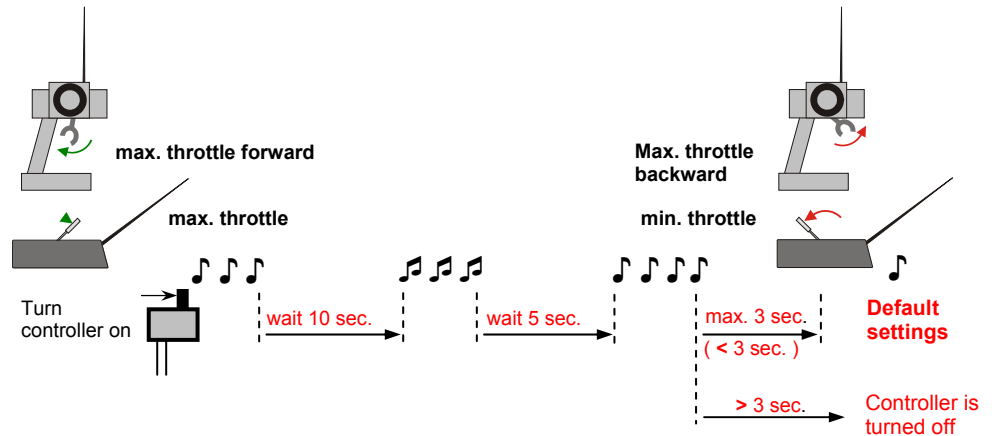

Together with motor beeping, LED on the controller blinks.

Programming table for controllers E3 and Z3 Rcae Boat, verzsn 6.0x

Parameter value →		0	1	2	3	4	5	6	7	8	9	10
Parametr		(Enter)										
A	Choice of mode	next parameter	„BOAT“ mode unidirectional x ●▶	„BOAT“ mode bidirectional ◀●x	--	--	--	sensor +) motor tuning				
B1	Number of cells *) (units)	next parameter	0	1 cell	2 cells	3 cells	4 cells.	5 cells.	6 cells	7 cells	8 cells	9 cells
B2	+ number of cells (tens of cells)	next parameter	0	1 (= 10 cells)	2 (= 20 cells)							
C	Type of cells	next parameter	<u>Automat 78%</u>	Nixx	Li-xxx	A123	UNI 1V	UNI 2V	UNI 3V	UNI 4V		
D	Switching-off voltage:	next parameter										
D	Nixx		0.80 V	0.84 V	0.88 V	0.92 V	0.96 V	1.00 V	1.04 V	1.08 V	1.12 V	1.16 V
D	A123		2.00 V	2.10 V	2.20 V	2.30 V	2.40 V	2.50 V	2.60 V	2.70 V	2.80 V	2.90 V
D	Li-xxx		2.90 V	3.00 V	3.10 V	3.20 V	3.30 V	3.40 V	3.50 V	3.60 V	3.70 V	3.80 V
D	Universal: UNI xV	+	0.00 V	0.10 V	0.20 V	0.30 V	0.40 V	0.50 V	0.60 V	0.70 V	0.80 V	0.90 V
E	Throttle limits	next parameter	<u>Automatic limits</u>	Limits according to transmitter								
F	Deceleration from 100 to 0%	next parameter	Without dec.	0.13 sec.	0.26 sec.	0.39 sec.	<u>0.65 sec.</u>	1.3 sec.	1.8 sec.	2.3 sec.	3.0 sec.	
G	Acceleration from 0 to 100%	next parameter	0.13 sec.	0.26 sec.	0.39 sec.	<u>0.65 sec.</u>	1.3 sec.	1.8 sec.	2.3 sec.	3.0 sec.		
J	Width of the neutral zone	next parameter	6%	9%	12%	<u>15%</u>	18%	21%	24%			
K	Power reduction in reverse gear	next parameter	NO (=100%)	80%	60%	<u>40%</u>						
L	BEC voltage **)	next parameter	<u>5V</u>	6V								
M	Behavior when batteries are getting low	next parameter	<u>Power reduction</u>	Immediate cut-off	Race mode 1 Current fuse + voltage fuse turned off	Race mode 2 only current fuse turned off						
N	Motor timing	next parameter	<u>automatic</u>	5°	10°	15°	20°					
O	Reversal of motor revolutions	next parameter	<u>NO</u>	YES								
P	PWM frequency	next parameter	<u>8 kHz</u>	16 kHz	32 kHz							
R	Type of motor +) (only SE versions)	next parameter	<u>Brushless sensorless</u>	Brushless sensors								
S	Max. temperature of the motor +) (only SE versions)	end of programming	<u>NO</u>	70°C	80°C	90°C	100°C	110°C	120°C	130°C	140°C	150°C

Default settings marked as bold, underlined blue print

*) maximal number of Lipol cells for a specific controller is given by technical specifications of each type of controller (page 10)

**) this parameter is not considered for OPTO versions of controller – whatever you set, it has no effect

+) this parameter is only available for sensor version of controllers (marked SE)

6) Description of each parameter in the programming mode:

Parameter A – mode: Choice of „BOAT“ mode (bidirectional or unidirectional operation) or „**Motor Tuning**“ (automatic tuning of sensor motors) mode.

BOAT mode unidirectional [A1]: moving the throttle stick from neutral backwards causes only braking and not transition in the opposite direction of motor revolutions.

BOAT mode bidirectional [A2]: In this mode, parameter „F“ means the intensity of decreasing revolutions of motor from maximum to standstill (deceleration speed). Transition from one direction is instantaneous, with speeds of deceleration and acceleration set in parameters "F" and "G", respectively. Only move throttle stick to the opposite direction.

Motor Tuning [A6]: this mode is designed for optimization of sensor motors' control (available only for version „SE“). When this mode is set and saved (whether it is done using transmitter, PC or UNICARD) the controller confirms this mode by „beep – beep – beeeeeep“. Move the throttle stick forward, motor will start turning, the necessary measurements will be done and motor will stop. Gear box must be disconnected from the motor (eg. by taking pinion out, etc.).

Parameter B – number of cells: Setting of number of used cells (Li-xxx, A123 and UNI x) It is necessary to set parameter B1 and B2 (units and tens of cells - for less than 10 cells B2 is set to "0"). Then, you automatically proceed to parameter "C".
When "Automat 78%" or Nixx is set, this parameter B has no meaning, it is not considered whatever the number of cells set.

Parameter C – type of cells: it is possible to choose either one of the preset cells, Nixx, Li-xxx or A123 or you can choose a „virtual“ UNI cell with a basic voltage of 1V, 2V, 3V or 4V. This choice is closely connected with the next parameter – switching-off voltage. It will enable you to set a particular switching-off voltage even for cells that do not yet exist today with 0.1V step.
It is also possible to set „Automat 78%“. For this choice, the switching off voltage is set to 78% of voltage of battery at the time of turning the controller on. The advantage is that it is not necessary to set anything else, not even the number of cells. The disadvantage of this choice is the possibility of discharging the cells too much if you turn the controller on with already a partially discharged battery pack.

Parameter D – switching off voltage: Enables to set optimal switching-off voltage for particular cells and according to your needs. For each type of cell (except for „Automat 78%“) chosen in the previous parameter (C), respective switching off voltages are available, more see page 12, paragraph "switching of voltage".
Setting a higher value will not only ensure larger energy reserves after the motor is switched off (advantageous for gliders and termic flying), but also lower the possibility of undercharging the weakest cell in the pack.

Parameter E – throttle limits: it is possible to choose from automatic setting or setting according to the transmitter with saving the limit values and the neutral position.
– **Automatic setting** is advantageous because you do not have to set or program anything even when you change the transmitter setting (on channel throttle) or use different transmitter or receiver. The disadvantage is that you have to show the controller the throttle limits after each turn on of the controller by moving the throttle forwards and backwards, respectively minimal and maximal throttle, for more see chapter „Quick Start“ on separate sheets.
– **Setting limit positions according to the transmitter** is better, the controller saves the set limits, so that the control is set from the beginning to whole throttle range of your transmitter/receiver. The disadvantage is that when you change the transmitter or the deflections of the throttle, or you change the receiver, you have to set the limits again. However that is done by only entering the programming mode using transmitter and turn the controller off. You do not have to program any parameters. The controller determines the real limit positions of your transmitter and saves them, for more see „Quick Start“ on separate sheets.

Parameter F – deceleration: Enables to set deceleration (speed of deceleration of the motor) in 8 levels. This is important mainly when going from full throttle forward to full throttle backwards (and vice-versa). That is, motor decelerates to zero with the set speed and then accelerates to the other direction with the speed set in parameter "G" - acceleration. Set according to your needs.

Parameter G – acceleration: enables to set acceleration (speed of acceleration of the motor from 0 to 100% of the power) in 8 levels. Set according to your needs. The faster the acceleration set, the higher the current peak during start up (and vice-versa).

Parameter J – width of the neutral zone (applies only to transmitters with neutral): it is a zone in the throttle stick range which is considered as a „neutral“ by the controller. In this zone the motor is stopped. The controller also returns to regular operation from this position after switch off due to overloading. Too narrow zone may not be reliably evaluated, too wide zone narrows the area of throttle regulation. With some types of transmitters, loosening of throttle potentiometer occurs during operation, which causes different position of neutral for transitions from „throttle forward“ and different from „brake“. This mechanical malfunction must be eliminated by either setting a significantly higher value of this parameter or even better by fastening the fastening nut of the throttle potentiometer.

Parameter K – power reduction in „reverse gear“: It is possible to reduce the maximal power of motor when riding backwards (in reverse gear) using this parameter.

Parameter L – BEC voltage: It is possible to set the BEC voltage to regular 5V or higher value of 6V in this parameter. Higher voltage is suitable if you need bigger force and speed of servos. **For OPTO version, setting this parameter has no effect, whatever you set.**

Parameter M – behavior when batteries are getting low: It is possible to set **gradual lowering of revolutions** or **immediate cut off** (with the possibility of turning on again after throttling down to neutral). It depends on customs of the driver.

Race mode 1: The motor is switched off only when the voltage of batteries drops below ca 3.5V (LV versions) or 5V (versions with BEC) or 8.5V (OPTO version), it does not depend in the number of cells, their condition, current etc. It is possible to regain the operation after throttling down to neutral. This mode is rather drastic for batteries, particularly for bigger number of cells !!! The current fuse is inactivated (that is, the controller does not watch the maximal currents !!!), the temperature fuse is set to 105°C. The warranty does not apply to possible damage of the controller in this mode.

Race mode 2: Only the current fuse is inactive (the controller does not watch the maximal currents !!!), the temperature fuse is set to 105°C. Voltage of cells is watched and the controller switches off according to set switch-off voltages (parameters B, C, D). The warranty does not apply to possible damage of the controller in this mode.

Parameter N – timing: It is possible to set 5 different timing values. Automatic timing is the sixth possibility. It is strongly recommended to keep this setting (on automatic timing) because it ensures optimal settings and maximal efficiency. While using the definite values of timing, you may rise the motor revolutions or the twisting moment a bit but always at the expense of lowering the efficiency. If you wish to have higher revolutions it is better to use different motor or more cells because lower efficiency (due to higher timing) cannot be made up for. High value of timing may, in an unsuitable combination with some motors, damage the controller !

For motors with high inductance (eg. some AXI or LRK or some motors from CD mechanics) it is necessary to set the timing to 5°, 10° or even 15°, as automatic timing may not be optimal here (the loss of synchronization can be easily recognized by motor jerking in higher revolutions and higher loads).

Parameter O – reversal of motor revolutions: This parameter sets the desired direction of motor revolutions without having to swap two wires to motor, when the motor is turning the other way.

Parameter P – PWM frequency: Using this parameter you set suitable frequency for motor control (PWM). If you have a regular motor, set the frequency to 8kHz. If your motor requires higher frequency set the corresponding closest value (eg. Tango by Kontronik has 32kHz etc.) Mostly, these are called ironless motors. Using low frequency for motors requiring high frequency (e.g. 8kHz for Tango motor) leads to damage of the controller in most cases. The warranty is not valid for such damages of the controller.
Higher frequency of motor control means higher switching losses of the controller and the controller is heated up more. This leads to higher cooling demands, eventually it is also necessary to proportionally reduce maximal power (current) of the controller.

Parameter R – type of motor: It is possible to set sensor or sensorless motor. Parameter is available only for „SE“ version controllers, which enable operation of sensor motors as well as sensorless motors. For other versions the parameter is not available and programming ends with parameter „P“.

Parameter S – temperature of motor: It is possible to set a maximal allowable motor temperature. The temperature is measured by sensor directly built-in the motor (sensor motors) or by external sensor outside the motor (sensorless motors). Parameter is available only for „SE“ versions.

PROGRAMMING the TMM xxxx – 3, RACE BOAT controllers, range E3, range Z3

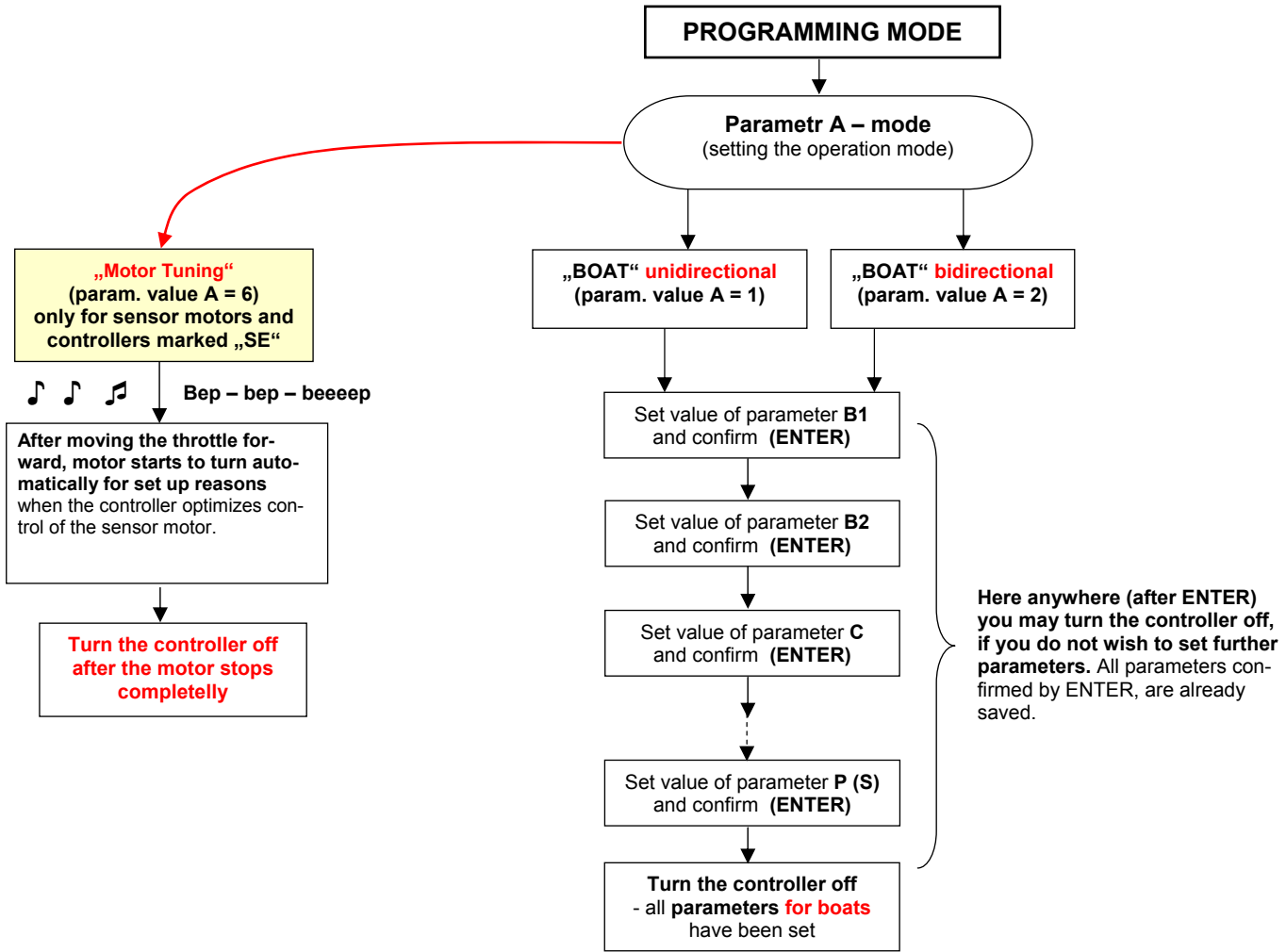

Error messages (the controller must be switched off to correct the error, then switched on again):

- Throttle stick was moved the opposite way then it is supposed
- Low size of deflection of control pulses – you must increase the size of deflection of the throttle stick on the transmitter
- Exceeding the border limits of control pulses (0.7ms and 2,3 ms) – you must shorten the size of deflection of the throttle stick on the transmitter
- Starting with an overheated controller
- More or less cells than specified
- Current overload
(resumes operation after dropping throttle to zero, it is not necessary to switch the controller off in this case)

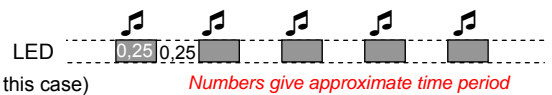

- Long lasting signal drop out
- controller waits for the throttle to get to „NEUTRAL“ positon
(or to „min throttle“ for transmitters without neutral)

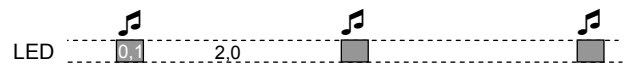

motor is not suitable for the controller or it is fed by too high voltage or is short-circuited or necessary is set higher PWM frequency (only LED blinks, not acoustic signalization)



- Continuous beep after switch on – corrupted data in EEPROM. The controller is in default settings.
It is necessary to reprogramm the controller!
If the problems persist please contact the service department.

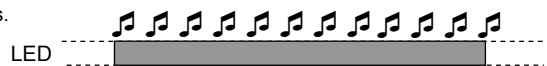

The default settings is a follows:

- unidirectional mode
- throttle limits - automatic
- type of cells – not specifies, automatic
- Automatic setting of switching-off voltage to 78% of voltage of cells while turning the controller on, type of cells is not considered
- deceleration 0.65 seconds
- acceleration 0.65 seconds
- motor timing automatic
- range of neutral zone 15%
- (power reduction in reverse gear – 40%)
- BEC voltage 5V
- behavior when batteries are getting low – „power reduction“
- reversal of motor revolutions – no
- motor PWM frequency 8 kHz
- type of motor – brushless sensorless
- temperature of motor – unwatched

TRANSMITTERS with NEUTRAL throttle (with latched middle position of the throttle):

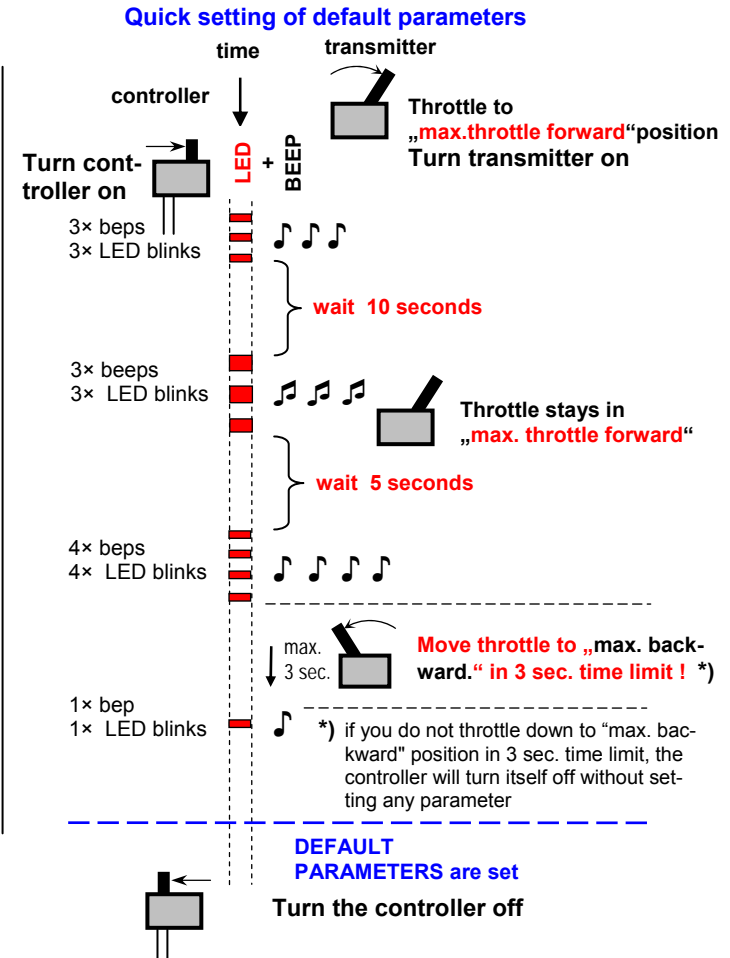
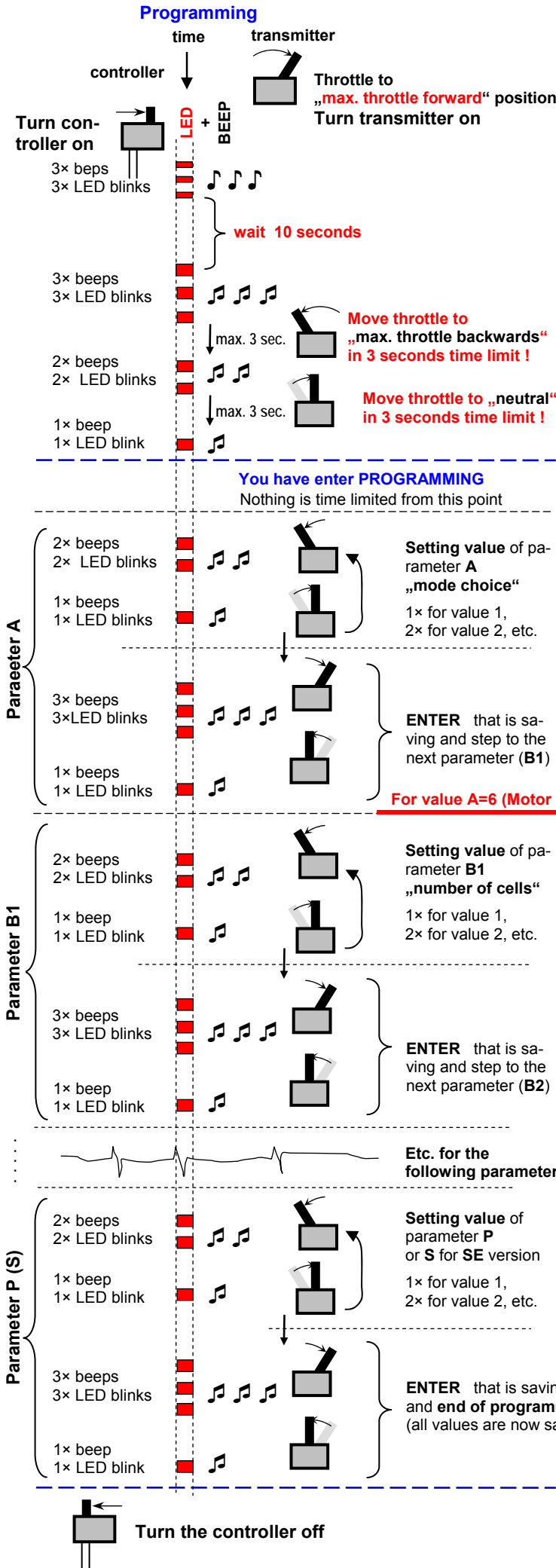

For value A=6 (Motor Tuning), only SE versions

bep – bep – beep

Move throttle forward

Motor will automatically start turning for 2 – 3 seconds and then will stop. Controller optimizes the sensor setting. It is recommended to do this without pinion on motor or with a motor outside of model.

Here you may anywhere, after confirming by ENTER, turn the controller off if you do not wish to change the following parameters.

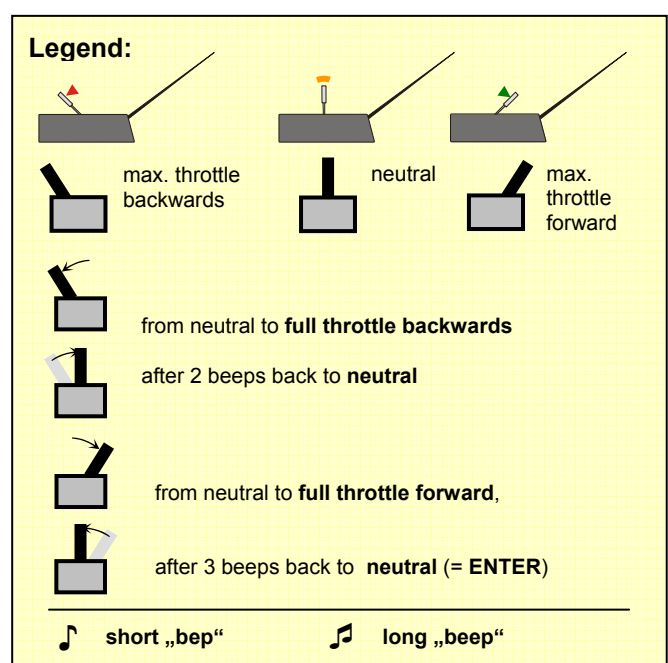

TRANSMITTERS without NEUTRAL throttle (applies only for „unidirectional boats“ mode):

Programming

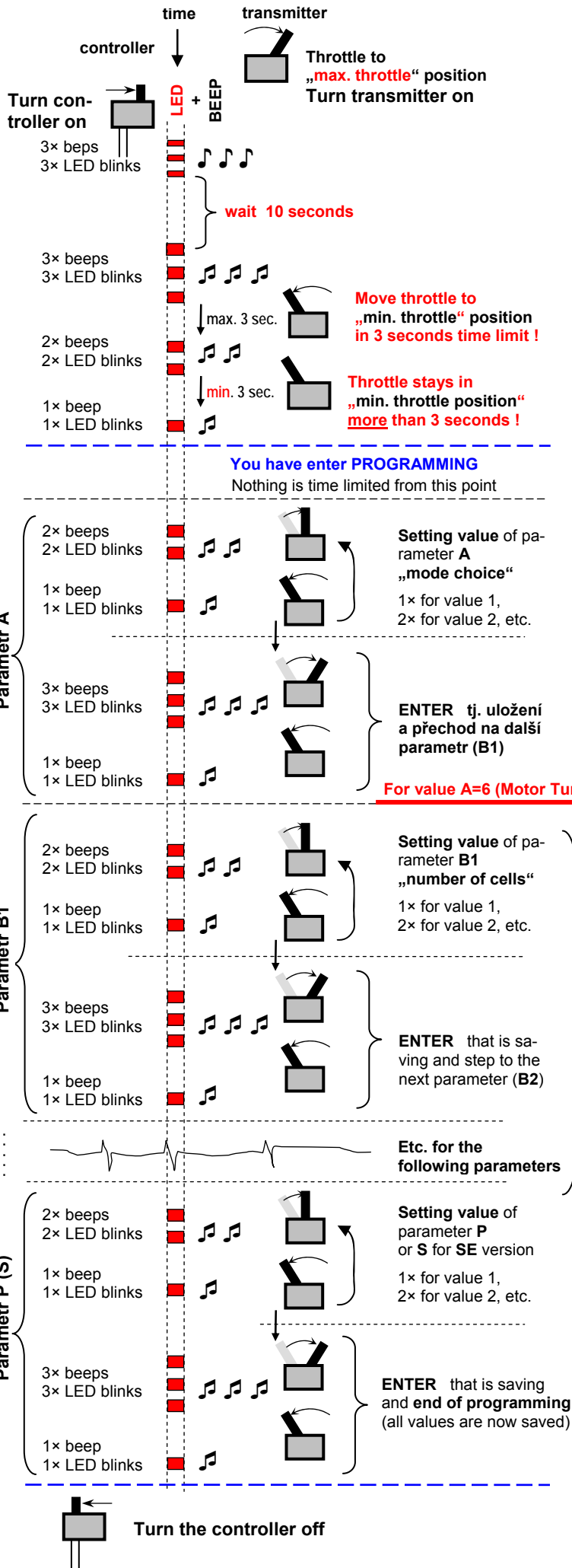

Quick setting of default parameters

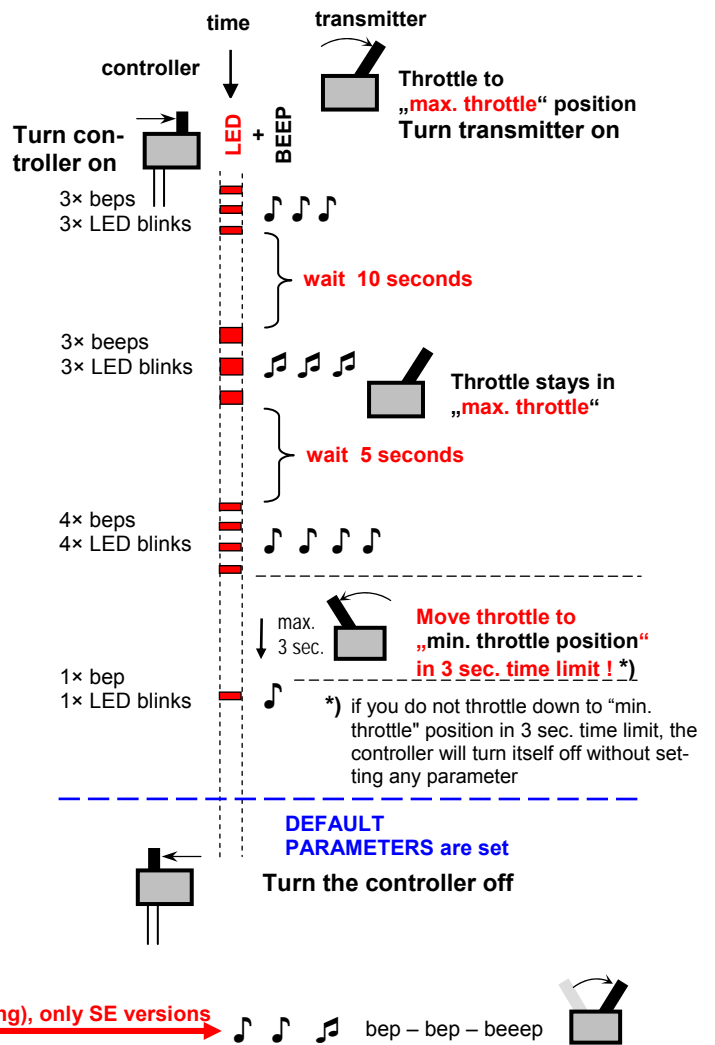

Move throttle forward

Motor will automatically start turning for 2 – 3 seconds and then will stop. Controller optimizes the sensor setting. It is recommended to do this without pinion on motor or with a motor outside of model.

Here you may anywhere, after confirming by ENTER, turn the controller off if you do not wish to change the following parameters.

Legend:

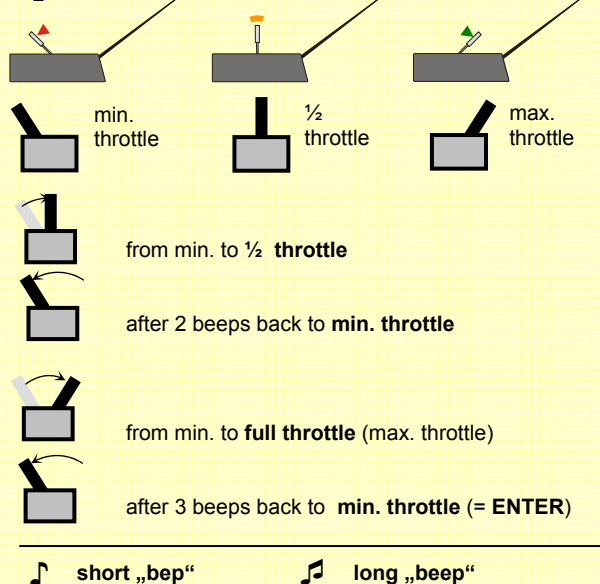

8) Technical data:

Temperature of the environment:	0°C up to 40°C	number of steps of motor control:	1024 / full throttle
Motor control:	PWM: 8, 16, 32 kHz	Max. rpm for 2 pole motor:	200 000 rpm
Control signal:	Positive pulses 1.5 ± 0,8 ms, period 10 up to 30 ms + HRS modulation		
S BEC (switched BEC):	5V / 6V max. 6.0 A (for loadability see graph), input voltage = 6 up to 25.5V (except for OPTO versions)		
Power supply:	only from batteries: NiCd, NiMH, Li-Ion, Li-Pol, A123, possibly also lead or others		
Switch:	all controllers may be ordered with a switch (in a safe design - its damage or destroy does not affect the safety of flight and the model)		
Suitable for motors:	Mega AC, Model Motors, MP JET, PJS, Überall model, Hacker, Kontronik, LRK, Plettenberg, Lehner, Neu, Align, etc.		
sensorless -	for 2 up to 30 pole motors of classical conception (rotor inside) and motors with rotating cover – so called outrunners (rotor outside).		
sensor motors -	some types of controllers may be ordered as „Sensor“ – marked as SE (eg. TMM 8025-3 C/B SE). These controllers may be connected to sensorless motors as well as sensor motors. In case of sensor motors, only types compatible with EFRA recommendations may be used. (EFRA Handbook 2007), eg. motors „Velocity x.xR Brushless Motor“ by Novak, etc., more see next page.		
Heat sinks (coolers):	if from any reason you do not wish to use a standardly supplied water cooling, it is possible to optionally mount (from one, or both sides depending on the type of the controller) outer ribbed heat sinks (coolers) - the width of the controller will rise by 3.6 mm (7.2mm), weight increases by 6 (12) grams, best with a fan.		
Fans:	In case of insufficient cooling air flow when using ribbed heat sinks it is possible to use heat sinks with fans (8.5 gr./pc), which significantly improve the cooling efficiency – active cooling.		
Water cooling:	„Race Boat“ range controllers are standardly supplied with water coolers.		
Hydro version:	water and humidity does not get on well with electronics. For significant increase of durability of the controller against humidity and water, „Race Boat“ range controllers have a speciality protective cover (marked as WP) applied standardly. This however does not mean that the controller with this protection is 100% durable during humidity and water and that it is not necessary to protect it against these negative effects. The protection does not apply to salt water at all!		

Controllers for higher powers (HP):

E-series / Z-series TMM® xxxx-3	V 6.0x	6025-3	8025-3	12025-3	16025-3	28025-3	8017-3LV	16017-3LV
Dimensions (without external capacitor) [mm]:	50×31×12	50×31×12	50×31×12	50×31×17	50×31×17	50×31×21	50×31×12	50×31×17
Dimensions (incl. external capacitor) [mm]:	65×31×12	65×31×12	65×31×12	65×31×17	65×31×17	65×31×21	65×31×12	65×31×17
Weight inc. all power conductors:	51 g	51 g	51 g	71 g	71 g	113 g	51 g	71 g
Weight without power conductors:	36 g	36 g	36 g	45 g	45 g	75 g	36 g	45 g
Feeding voltage:	6 – 25.5 V	6 – 25.5 V	6 – 25.5 V	6 – 25.5 V	6 – 25.5 V	6 – 25.5 V	3.5 – 17 V	3.5 – 17 V
No. of feeding NiCd / NiMH cells:	6 – 18	6 – 18	6 – 18	6 – 18	6 – 18	6 – 18	4 – 12	4 – 12
No. of feeding Li-Ion / Li-Pol cells:	2 – 6	2 – 6	2 – 6	2 – 6	2 – 6	2 – 6	2 – 4	2 – 4
No. of feeding A123 cells:	3 – 7	3 – 7	3 – 7	3 – 7	3 – 7	3 – 7	2 – 4	2 – 4
Max continuous current (in full throttle):	60 A	80 A	80 A	120 A	160 A	280 A	80 A	160 A
Peak current for max. 5 seconds time periods:	75 A	100 A	100 A	150 A	200 A	340 A	100 A	200 A
On-state FET resistance at 25°C:	2×0,8 mΩ	2×0,7 mΩ	2×0,7 mΩ	2×0,4 mΩ	2×0,35 mΩ	2×0,18 mΩ	2×0,55 mΩ	2×0,28 mΩ
Version:	S BEC	S BEC	S BEC	S BEC	S BEC	S BEC	S BEC	S BEC
S BEC voltage:	5V / 6V	5V / 6V	5V / 6V	5V / 6V	5V / 6V	5V / 6V	5V / 6V	5V / 6V
Power wires cross section (to batt./to motor):*)	2,5/2,5 mm ²	2,5/2,5 mm ²	2,5/2,5 mm ²	4/4 mm ²	6/4 mm ²	6/4 mm ²	2,5/2,5 mm ²	4/4 mm ²
Servicable with JR gold connector:	0,25 mm ²	0,25 mm ²	0,25 mm ²	0,25 mm ²	0,25 mm ²	0,25 mm ²	0,25 mm ²	0,25 mm ²
Possibly compatible with sensor motors:	version SE	version SE	version SE	version SE	version SE	version SE	version SE	version SE
Improved durability against overloading:	yes	yes	yes	yes	yes	yes	yes	yes
Possibility mounting of air cooled heat sinks:	yes	yes	yes	yes	yes	yes	yes	yes
Possibility of active cooling – fan(s):	yes	yes	yes	yes	yes	yes	yes	yes

E-series / Z-series TMM® xxxx-3	V 6.0x	7035-3	14035-3	25035-3	6245-3	12545-3	10063-3
Dimensions (without external capacitor) [mm]:	50×31×12	50×31×17	50×31×17	50×31×22	50×31×17	50×31×22	50×31×22
Dimensions (with external capacitor) [mm]:	80×31×12	80×31×17	80×31×17	65×31×22	80×31×17	80×31×22	80×31×22
Weight inc. all power conductors:	54 g	77 g	77 g	119 g	77 g	119 g	119 g
Weight without power conductors:	39 g	50 g	50 g	81 g	50 g	81 g	81 g
Feeding voltage:	9 – 35 V	9 – 35 V	9 – 35 V	9 – 35 V	9 – 45 V	9 – 45 V	9 – 63 V
No. of feeding NiCd / NiMH cells:	9 – 24	9 – 24	9 – 24	9 – 24	9 – 32	9 – 32	9 – 44
No. of feeding Li-Ion / Li-Pol cells:	3 – 8	3 – 8	3 – 8	3 – 8	3 – 10	3 – 10	3 – 15
No. of feeding A123 cells:	4 – 9	4 – 9	4 – 9	4 – 9	4 – 12	4 – 12	4 – 17
Max continuous current (in full throttle):	70 A	140 A	140 A	250 A	62 A	125 A	100 A
Peak current for max. 5 seconds time periods:	90 A	180 A	180 A	300 A	77 A	155 A	125 A
On-state FET resistance at 25°C:	2×1,1 mΩ	2×0,55 mΩ	2×0,55 mΩ	2×0,28 mΩ	2×1,0 mΩ	2×0,50 mΩ	2×0,76 mΩ
Version:	OPTO	OPTO	OPTO	OPTO	OPTO	OPTO	OPTO
BEC voltage:	--	--	--	--	--	--	--
Power wires cross section (to batt./to motor):*)	2,5/2,5 mm ²	6/4 mm ²	6/4 mm ²	6/4 mm ²	2,5/2,5 mm ²	4/4 mm ²	4/4 mm ²
Servicable with JR gold connector:	0,25 mm ²	0,25 mm ²	0,25 mm ²	0,25 mm ²	0,25 mm ²	0,25 mm ²	0,25 mm ²
Possibly compatible with sensor motors:	version SE	version SE	version SE	version SE	version SE	version SE	version SE
Improved durability against overloading:	yes	yes	yes	yes	yes	yes	yes
Possibility mounting of air cooled heat sinks:	yes	yes	yes	yes	yes	yes	yes
Possibility of active cooling – fan(s):	yes	yes	yes	yes	yes	yes	yes

*) Notice: possibly also 2×2,5 mm² or 2×4,0 mm² upon request
The appearance and the technical data may be changed without prior notice.

Marking: TMM pppnn-3s, where „ppp“ means current (2 – 3 digits), „nn“ gives voltage (2 digits), „s“ version with a switch

Example: TMM 8035-3 80A, 35V, without switch
TMM 12545-3s 125A, 45V, with switch

Notice: Controller marking is changed compared to the old one. Number giving current and number of Nixx cells is changed to number giving max. current (first 2 to 3 digits) and max. voltage (second 2 digits). Marking with number of Nixx cells is not useful today, as also other cells like Lipol, A123 and also possibly other cells will be used in the future (controllers made provisions for that), therefore marking the controller with voltage makes more sense.

Recommendations: If you use controller for currents higher than ca 1/3 of maximal values, we do recommend intensive water cooling or use of heat sinks (possibly also active cooling using fans). This will not only prevent possible overheating of the controller, but you will also gain higher efficiency of the drive unit (cooler controller has lower losses than warm one).

9) Protective and safety mechanisms of TMM® controllers:

Controllers mask interference and signal losses for as long as 1.5 seconds. Motor revolutions are gradually reduced for longer lasting signal drop outs or interference. When the signal is restored, the controller goes smoothly back to the required power. Long lasting signal drop out (or its absence) is indicated acoustically by motor as well as by LED. This comes in handy when e.g. looking for a lost model.

Motor does not start, if the controller does not receive a correct signal from the receiver (e.g. when the transmitter is turned off). It also does not start until the throttle stick is not in „motor turned off“ position after switch on – that is in the neutral position for "grip pistols" transmitter type or „minimal throttle“ for transmitters without neutral.

Temperature fuse of the controller is set to 90°C, when the power is reduced to ca 60%. After cooling off (even during the flight), the controller goes back to the required power. After switch on, temperature is checked and if it is above 70°C, the controller does not start. New start is possible after the controller is cooled off below this value.

Current fuses of the controller turn the controller off or limit the currents during current overload of the controller. New start, after fuse cut off, is possible after the throttle is moved back to neutral (minimal position for transmitters without neutral).

Circuits monitoring voltage take care of the correct moment for disconnecting the motor when the batteries get discharged – not only that the batteries do not get undercharged but also enough energy is retained for servos after the motor is turned off (when the battery is discharged).

Advantages of these mechanisms for TMM® controllers:

- 1) Thanks to the use of the automatic current fuse (ACF) the possibility of current overload of controller, motor and accumulators (and their possible damage) even at crisis points is significantly reduced - controller disconnects the motor.
- 2) the used system of intelligent power reduce (IPR) always ensures through measurements of voltage, currents, accumulator condition and calculations an optimal point of starting continuous reduction of motor performance (or the point when motor is switched off, according to the setting), so that the accumulator cells do not get extremely discharged – which is very important specially for Lipol cells. This, not mentioning other advantages, reduces the possibility of reversal of poles of lower cells (applies mainly to NiCd / NiMH cells).
- 3) This system at the same time **enables retaining defined energy for BEC (perfect RPC)** – applies to controllers with BEC. It is extremely important for flying models (you do not crash due to not having enough energy for receiver and servos). The amount of retained energy can be set by the user (by setting the switch-off voltage).
- 4) the automatic current reduce (ACR) does not allow a drop in voltage for BEC even under extremely big current load.

When switching the motor off (reducing power) at a solid boundary as it is with standard controllers (**chart a**) it is not possible to determine the amount of energy for BEC which is kept in the controller after the motor is switched off. It strongly depends on currents and inner resistance of the battery. The better the cells (harder) you have and the smaller the instantaneous current, the less energy (= time) remains for landing after the motor is switched off by the controller. On the other hand, the worse the cells and the higher the instantaneous currents, the more energy remains – but you do not know how much energy exactly. Comparing to this, TMM controllers (**chart b**) ensures that the remaining energy (after the motor is switched off by the controller) is practically independent on currents and inner resistance of the battery and it is possible to change its amount for some types of controllers according to one's needs (higher for gliders, etc.). From the motor operation time view it is usually an insignificant amount of energy, the motor power would decrease very fast anyway. However, this energy is very significant in regards to feeding BEC.

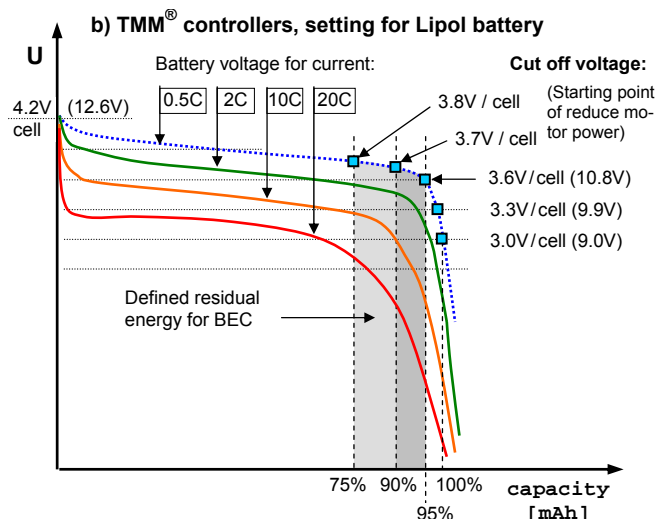
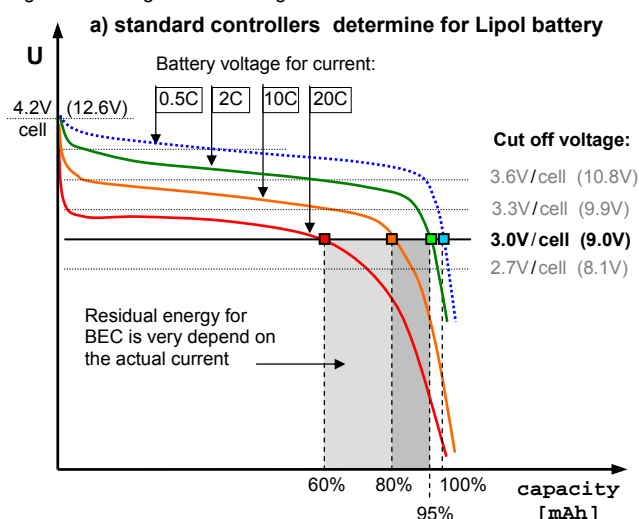

Regular controllers (even Lipol compatible) have either a solid switching off voltage (for example 3V per cell) or it is possible to set this value. For example for set boundary 3V per cell the controller is switch off or it starts to reduce revolutions when this value is reached no matter how big the drawn current is. **This means that the residual energy significantly changes according to an instantaneous current load of batteries** (and also according to inner resistance of the cells) from 0 to 95% - depending only on the set voltage boundary. If the example on the graph above is considered with a set boundary of 3V per cell the controller will switch off when drawn current is 20C when there is still 40% of energy still left, while for 5C current when only 5% of energy is left. For boundary of 3.3V per cell the controller would switch off for currents of 20C when only few percent of energy were consumed while for 5C after 92% of energy would be consumed.

TMM® controllers handle the situation quite differently. The switching off voltage is always recalculated into „inner“ voltage of the battery – therefore is independent on both drawn current as well as inner resistance of the accumulator. **This means the set residual energy is always the same and does not depend on currents and inner resistance of battery.** Batteries are then always discharged to same level, regardless how big currents are drawn. The value of set residual energy is therefore only little dependent on the features of battery and the discharging current. For example for switching voltage 3.7V per cell controller switches off the motor or starts to reduce revolutions always after 90% of energy is used up no matter if the drawn current is 20C or 5C. (The voltage of accumulator after switch of the current always rises to a value close to curve of 0.5V – this discharging curve is close to „inner“ voltage of battery. This curve describes how much the controller is discharged.

Switching-off voltage:

Thanks to the described mechanisms, the switching—off voltage (always ment as switching-off voltage / cell!) of TMM® controllers is independent on the amount of drawn current and the inner resistance of accumulators. For each type of cells (parameter C), particular switching—off voltage may be set in parameter D. The controllers also feature universal possibility to set switching-off voltage for types of cells that do not even exist today. According to the minimal voltage of such cells you choose in parameter C type UNI 1V, UNI 2V etc. which corresponds to the basic switching-off voltage of 1V, 2V etc. This voltage is added to the value set in parameter D, in the range of 0.0V to 0.9V which thus enables you to set the switching-off voltage from 1.00V up to 4.90V / cell. In case of new accumulators with even higher voltage, the basic values of UNI (the highest today is UNI 4V) may be enlarged as needed – just by updating the SW of the controller on the MGM website using internet.

When setting type of cells - Li-xxx, A123 or „UNI xV“ it is always necessary to also set the number of used cells (parameter B1 and B2) connected in serial!



Development, manufacture, service:

MGM compro, Ing. G. Dvorský
Sv. Čecha 593, 760 01 Zlín

Tel.: +420 577 001 350 Fax: +420 577 001 348

E-mail: mgm@mgm-compro.cz

Info: www.mgm-compro.com

Different versions of CAR-BOAT controllers of E-series and Z-series:

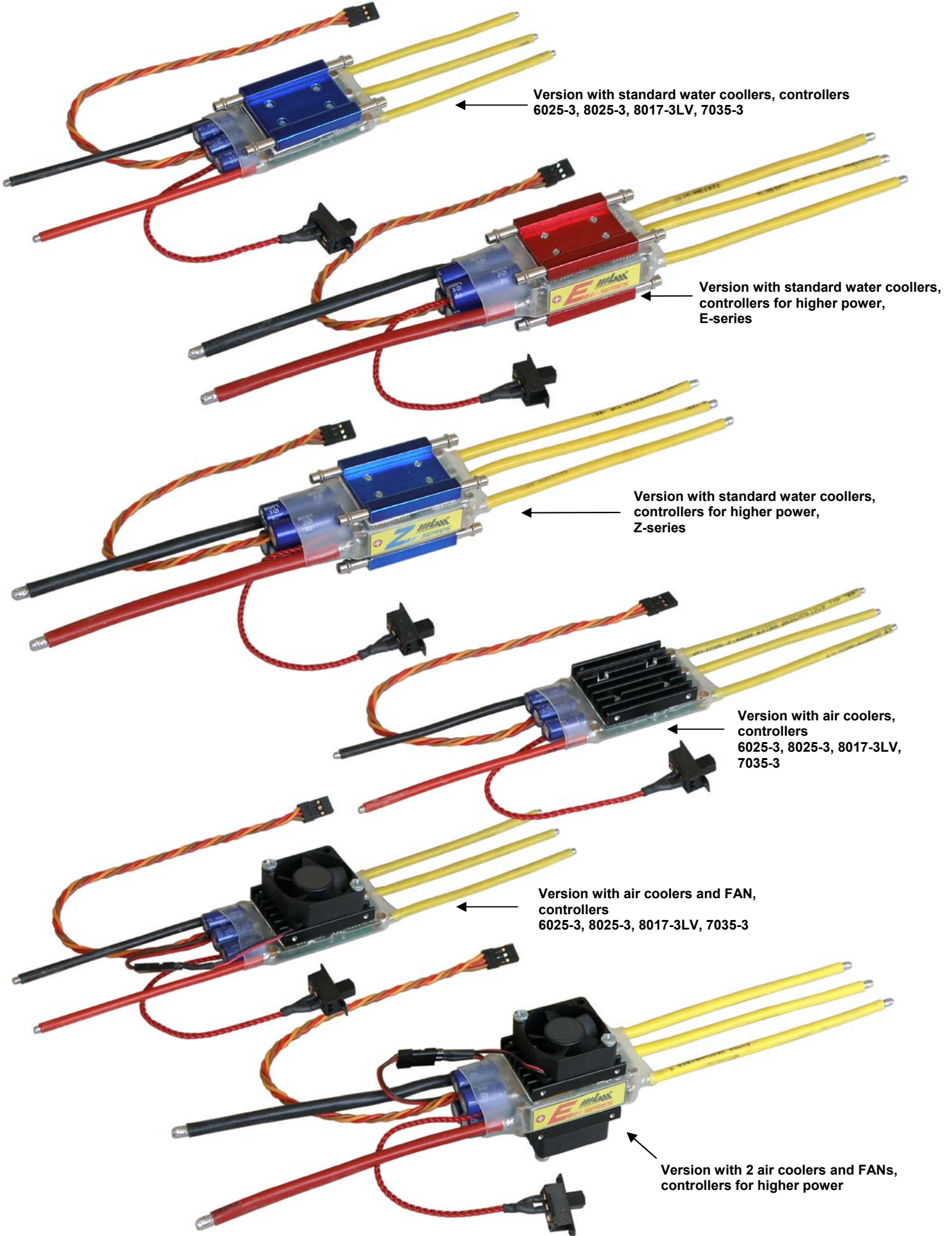

Version with standard water coolers, controllers 6025-3, 8025-3, 8017-3LV, 7035-3

Version with standard water coolers, controllers for higher power, E-series

Version with standard water coolers, controllers for higher power, Z-series

Version with air coolers, controllers 6025-3, 8025-3, 8017-3LV, 7035-3

Version with air coolers and FAN, controllers 6025-3, 8025-3, 8017-3LV, 7035-3

Version with 2 air coolers and FANs, controllers for higher power

10) Example: you want bidirectional bot mode, 4 Lipol cells with switching-off at 3.00V, throttle stick deflections according to the transmitter, BEC +6V, and PWM frequency of 16 kHz, other parameters as in default settings

a) Programming using transmitter with neutral:

- 1) Turn the transmitter on with the throttle stick in max forward position.
- 2) Turn the controller on. Controller shortly beeps 3x and after 10 seconds 3x long beeps will be heard. Move throttle to max. backwards (full brake), motor will produce 2 long beeps, move throttle to neutral, motor will produce 1 long beep. You have now entered the programming mode, controller knows the boundary positions and neutral of the transmitter and you may start programming the first parameter „A“ (see table). For bidirectional bot mode it is necessary to set value 2 in this parameter [A = 2].
- 3) Move the throttle stick from neutral to „full throttle backwards“, motor beeps 2x (long beeps). Move the throttle back to neutral, motor will produce 1 long beep. Repeat this procedure (full throttle backwards – neutral) as many times as is the value of the parameter - according to the table – which you wish to set. To set **value 2** repeat the procedure (full throttle backwards – neutral) **1** more times.
- 4) This setting must be confirmed by „ENTER“. Move the throttle stick from neutral to „full throttle forwards“ – motor produces 3 long beeps and move throttle back to neutral, motor makes 1 long beep - parameter is programmed to the set value and saved. „**bidirectional boat**“ mode is now set. You have automatically entered the next parameter, that is now - **B1**.
- 5) Now set 4 Lipol cells: Move the throttle stick from neutral to „full throttle backwards“, motor beeps 2x (long beeps). Move the throttle back to neutral, motor will produce 1 long beep. Repeat this procedure (full throttle backwards – neutral) as many times as is the value of the parameter - according to the table – which you wish to set. To set value 5 (=4cells) repeat the procedure (full throttle backwards – neutral) **4** more times.
- 6) This setting must be confirmed by „ENTER“. Move the throttle stick from neutral to „full throttle forwards“ – motor produces 3 long beeps and move throttle back to neutral, motor makes 1 long beep - parameter is programmed to the set value and saved. Now you have set „**4 cells**“, [B1=5]. You have automatically entered the next parameter, that is now - **B2**.
- 7) We will not change this parameter B2 (there are no „tens“ in number of cells“), therefore we will proceed with „ENTER“ directly. Move the throttle stick from neutral to „full throttle forwards“ – motor produces 3 long beeps and move throttle back to neutral, motor makes 1 long beep - parameter **B2** is skipped over and you are automatically on the next parameter which is now parameter **C**.
- 8) To set „Lipol cells“, the value of this parameter will be 3. Again the procedure is similar. Move the throttle stick from neutral to „full throttle backwards“, motor beeps 2x (long beeps). Move the throttle back to neutral, motor will produce 1 long beep. Repeat this procedure (full throttle backwards – neutral) as many times as is the value of the parameter - according to the table – which you wish to set. To set value 3 repeat the procedure (full throttle backwards – neutral) **2** more times.
- 9) This setting must be confirmed by „ENTER“. Move the throttle stick from neutral to „full throttle forwards“ – motor produces 3 long beeps and move throttle back to neutral, motor makes 1 long beep - parameter is programmed to the set value and saved. Now you have set „**Lipol cells**“, [C=3]. You have automatically entered the next parameter, that is now – parameter **D**, switching-off voltage.
- 10) Move the throttle stick from neutral to „full throttle backwards“, motor beeps 2x (long beeps). Move the throttle back to neutral, motor will produce 1 long beep. Repeat this procedure (full throttle backwards – neutral) as many times as is the value of the parameter - according to the table – which you wish to set. To set value 2 (switching-off voltage 3.00V) repeat the procedure (full throttle backwards – neutral) **1** more time.
- 11) This setting must again be confirmed by „ENTER“. Move the throttle stick from neutral to „full throttle forwards“ – motor produces 3 long beeps and move throttle back to neutral, motor makes 1 long beep - parameter is programmed to the set value and saved. You have now set „**switching-off voltage 3.00V/cell**“, [D=2]. You have automatically entered the next parameter, that is now – parameter **E**, throttle limits.
- 12) Move the throttle stick from neutral to „full throttle backwards“, motor beeps 2x (long beeps). Move the throttle back to neutral, motor will produce 1 long beep. Repeat this procedure (full throttle backwards – neutral) as many times as is the value of the parameter - according to the table – which you wish to set. To set value 2 (limits according to transmitter) repeat the procedure (full throttle backwards – neutral) **1** more time.
- 13) This setting must again be confirmed by „ENTER“. Move the throttle stick from neutral to „full throttle forwards“ – motor produces 3 long beeps and move throttle back to neutral, motor makes 1 long beep - parameter is programmed to the set value and saved. Now you have set „**limits according to transmitter**“, [E=2]. You have automatically entered the next parameter, that is now parameter **F** – brake.
- 14) Because we do not want to change the brake settings (parameter F), not even the acceleration speed (parameter G), both these parameters will be skipped over by „ENTER“. Move the throttle stick from neutral to „full throttle forwards“ – motor produces 3 long beeps and move throttle back to neutral, motor makes 1 long beep - parameter **F** is skipped over and you are automatically on the next parameter which is now parameter **G**.
- 15) Move the throttle stick from neutral to „full throttle forwards“ – motor produces 3 long beeps and move throttle back to neutral, motor makes 1 long beep - parameter **G** is skipped over and you are automatically on the next parameter which is now parameter **J** – width of neutral zone.
- 16) Because we do not want to change the setting of parameter J, not even the reduction of power in reverse gear (parameter K), both these parameters will be skipped by "ENTER" as in the previous steps 14 and 15 and we will proceed to next parameter **L** – voltage of BEC
- 17) Move the throttle stick from neutral to „full throttle backwards“, motor beeps 2x (long beeps). Move the throttle back to neutral, motor will produce 1 long beep. Repeat this procedure (full throttle backwards – neutral) as many times as is the value of the parameter - according to the table – which you wish to set. To set value 2 (BEC 6V) repeat the procedure (full throttle backwards – neutral) **1** more time.
- 18) This setting must again be confirmed by „ENTER“. Move the throttle stick from neutral to „full throttle forwards“ – motor produces 3 long beeps and move throttle back to neutral, motor makes 1 long beep - parameter is programmed to the set value and saved. You have now set „**BEC 6V**“, [L=2]. You have automatically entered the next parameter, that is now parameter **M**.
- 19) Because we do not want to change the setting of parameter **M**, **N** and **O**, all three of these parameters will be skipped by "ENTER" as in the previous steps 18 and we will proceed to next parameter **P** – PWM frequency.
- 20) Move the throttle stick from neutral to „full throttle backwards“, motor beeps 2x (long beeps). Move the throttle back to neutral, motor will produce 1 long beep. Repeat this procedure (full throttle backwards – neutral) as many times as is the value of the parameter - according to the table – which you wish to set. To set value 2 (frequency 16kHz) repeat the procedure (full throttle backwards – neutral) **1** more time.
- 21) This setting must again be confirmed by „ENTER“. Move the throttle stick from neutral to „full throttle forwards“ – motor produces 3 long beeps and move throttle back to neutral, motor makes 1 long beep - parameter is programmed to the set value and saved. You have now set „**PWM frequency 16 kHz**“, [P=2]. You have automatically entered the next parameter, that is now parameter **R** (for sensor controllers marked **SE**). **This is the end of programming for sensorless controllers, turn the controller off.**
- 22) Because you do not wish to change the following parameters, switch off the controller. You have set all the required parameters.

b) Programming using UNICARD+:

- 1) Place a respective programming tag into **UNICARD+** (that is RACE BOAT E3 or Z3, V6).
- 2) Set the respective coupler in all parameters – for more information see user manual to UNICARD+. Connect the card to the controller (through **ICS** connector) using **CC_02** cable and **turn the controller on** - green LED on the card will start blinking and will stay lit after several seconds, now all your parameters are programmed.
- 3) Switch the controller off.
- 4) If you have not yet set the real limits of throttle using transmitter / receiver, which you use for this model, you have to set them now.
- 5) Turn the transmitter on with the throttle stick in max. forward position.
- 6) Turn the controller on. Controller shortly beeps 3x and after 10 seconds 3x long beeps will be heard. Move throttle to max. backwards (=full brake), motor will produce 2 long beeps, move throttle to neutral, motor will produce 1 long beep. You have entered the programming mode, the controller now knows its limit positions and neutral position.
- 7) Turn everything off, all is now set. After turning on again, you may start riding.

c) Programming using PC:

- 1) If you have controller with BEC, turn the transmitter on, throttle stick in neutral (precaution so that servos do not jerk). If you have OPTO controller you do not have to turn the transmitter on.
- 2) Run „**Controller version 1.2.xxx**“ application or its actual version (free downloads available from the company website).
- 3) Plug **USBCOM++** into USB port of you PC and to the controller using **ICS** connector and **CC_02** cable. Set all the required parameters using mouse and press „Write Data“ button. After the operation is finished, the controller is programmed according to your needs.
- 4) Switch the controller off.
- 5) If you have not yet set the real limits of throttle using transmitter / receiver, which you use for this model, you have to set them now.
- 6) Turn the transmitter on with the throttle stick in max forward position.
- 7) Turn the controller on. Controller shortly beeps 3x and after 10 seconds 3x long beeps will be heard. Move throttle to max backwards (full brake), motor will produce 2 long beeps, move throttle to neutral, motor will produce 1 long beep. You have entered the programming mode, the controller now knows its limit positions and neutral position.
- 8) Turn everything off, all is now set. After turning on again, you may start riding.